

BioMon Sensor
Datasheet
Preliminary Version 0.1

SFH7060



Features:

- Multi chip package featuring three green, one red, one infrared emitter and one detector
- Small package:
(WxDxH) 7.2 mm x 2.5 mm x 0.9 mm
- Light Barrier to block optical crosstalk
- Improved geometry for optimized signal quality

Applications

- Heart rate monitoring
- Pulse oximetry

for:

- Wearable devices (e.g. smart watches, fitness trackers, ...)
- Mobile devices

Besondere Merkmale:

- Multi-Chip-Gehäuse mit drei grünen, einem roten, einem infraroten Emitter und einem Detektor
- Kleines Gehäuse:
(BxTxH) 7.2 mm x 2.5 mm x 0.9 mm
- Lichtsperrung zur Unterdrückung von optischem Übersprechen
- Verbesserte Anordnung für optimierte Signal-Qualität

Anwendungen

- Herzfrequenzüberwachung
- Blutsauerstoff-Messung

für:

- Tragbare Geräte (z.B. Smartwatches, Fitnesstracker, ...)
- Mobile Geräte

Ordering Information SFH7060

Bestellinformation

Type	Ordering Code
Typ	Bestellnummer
SFH7060	Q65111A7791

Pin configuration

Pin	Name	Function
1	RA	Red LED Anode
2	RC	Red LED Cathode
3	G1C	Green LED 1 Cathode
4	G1A	Green LED 1 Anode
5	G2A	Green LED 2 Anode
6	PA	Photodiode Anode
7	PC	Photodiode Cathode
8	G2C	Green LED 2 Cathode
9	G3A	Green LED 3 Anode
10	G3C	Green LED 3 Cathode
11	IC	Infrared LED Cathode
12	IA	Infrared LED Anode

Top view

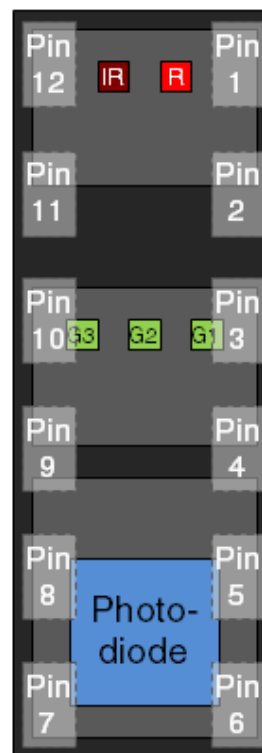

Block diagram

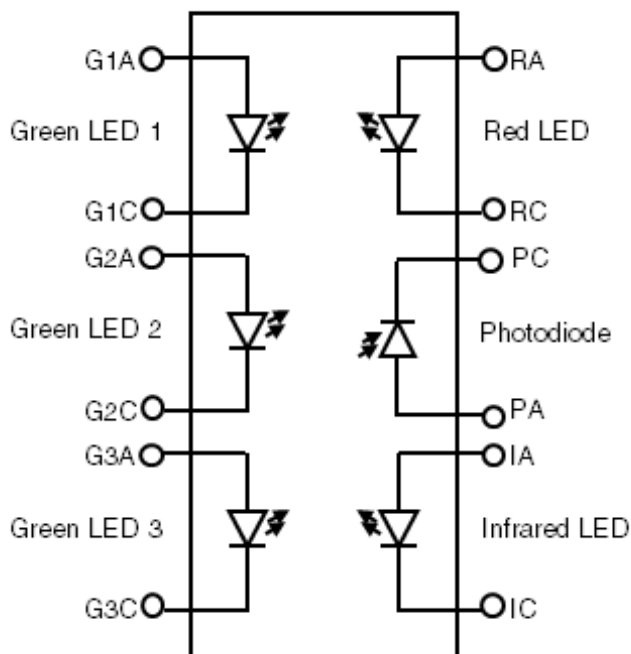

Maximum Ratings ($T_A = 25\text{ °C}$)

Parameter	Symbol	Values	Unit
General			
Operating temperature range	T_{op}	-40 ... 85	°C
Storage temperature range	T_{stg}	-40 ... 85	°C
ESD withstand voltage (acc. to ANSI/ ESDA/ JEDEC JS-001 - HBM)	V_{ESD}	2	kV
Infrared Emitter			
Reverse Voltage	V_R	5	V
Forward current	$I_{F(DC)}$	60	mA
Surge current ($t_p = 100\ \mu\text{s}$, $D = 0$)	I_{FSM}	1	A
Red Emitter			
Reverse voltage	V_R	12	V
Forward current	$I_{F(DC)}$	40	mA
Surge current ($t_p = 100\ \mu\text{s}$, $D = 0$)	I_{FSM}	600	mA
Green Emitters			
Reverse voltage	V_R	5	V
Forward current (single operation)	$I_{F(DC)}$	25	mA
Forward current (all three green emitters operation)	$I_{F(DC)}$	15	mA
Surge current (single and all three emitters operation) ($t_p = 100\ \mu\text{s}$, $D = 0$)	I_{FSM}	300	mA
Detector			
Reverse voltage ($I_R = 100\ \mu\text{A}$, $E_e = 0\ \text{mW/cm}^2$)	V_R	16	V

Note: The stated maximum ratings refer to single emitter chip operation, unless otherwise specified.

Anmerkung: Die angegebenen Grenzdaten gelten für den Betrieb einzelner Emitter Chips, wenn nicht anders angegeben.

Characteristics ($T_A = 25\text{ °C}$)

Parameter		Symbol	Value	Unit
Infrared Emitter				
Wavelength of peak emission ($I_F = 20\text{ mA}$, $t_p = 20\text{ ms}$)	(typ.)	λ_{peak}	950	nm
Centroid Wavelength ($I_F = 20\text{ mA}$, $t_p = 20\text{ ms}$)	(typ. (max.))	$\lambda_{\text{centroid}}$	940 (± 10)	nm
Spectral bandwidth at 50% of I_{max} ($I_F = 20\text{ mA}$, $t_p = 20\text{ ms}$)	(typ.)	$\Delta\lambda$	42	nm
Half angle	(typ.)	φ	± 60	$^\circ$
Rise and fall time of I_e (10% and 90% of $I_{e\text{max}}$) ($I_F = 100\text{ mA}$, $t_p = 16\text{ }\mu\text{s}$, $R_L = 50\text{ }\Omega$)	(typ.)	t_r, t_f	16	ns
Forward voltage ($I_F = 20\text{ mA}$, $t_p = 20\text{ ms}$)	(typ. (max.))	V_F	1.3 (≤ 1.8)	V
Reverse current ($V_R = 5\text{ V}$)		I_R	not designed for reverse operation	μA
Radiant intensity ($I_F = 20\text{ mA}$, $t_p = 20\text{ ms}$)	(typ.)	I_e	2	mW / sr
Total radiant flux ($I_F = 20\text{ mA}$, $t_p = 20\text{ ms}$)	(typ.)	Φ_e	5.3	mW
Temperature coefficient of I_e or Φ_e ($I_F = 20\text{ mA}$, $t_p = 20\text{ ms}$)	(typ.)	TC_I	-0.3	% / K
Temperature coefficient of V_F ($I_F = 20\text{ mA}$, $t_p = 20\text{ ms}$)	(typ.)	TC_V	-0.8	mV / K
Temperature coefficient of $\lambda_{\text{centroid}}$ ($I_F = 20\text{ mA}$, $t_p = 20\text{ ms}$)	(typ.)	$TC_{\lambda_{\text{centroid}}}$	0.25	nm / K

Characteristics ($T_A = 25\text{ °C}$)

Parameter		Symbol	Value	Unit
Red Emitter				
Wavelength of peak emission ($I_F = 20\text{ mA}$)	(typ.)	λ_{peak}	660	nm
Centroid Wavelength ($I_F = 20\text{ mA}$)	(typ. (max.))	$\lambda_{\text{centroid}}$	655 (± 3)	nm
Spectral bandwidth at 50% of I_{max} ($I_F = 20\text{ mA}$)	(typ.)	$\Delta\lambda$	17	nm
Half angle	(typ.)	φ	± 60	$^\circ$
Rise and fall time of I_e (10% and 90% of $I_{e\text{max}}$) ($I_F = 100\text{ mA}$, $t_p = 16\text{ }\mu\text{s}$, $R_L = 50\text{ }\Omega$)	(typ.)	t_r, t_f	17	ns
Forward voltage ($I_F = 20\text{ mA}$)	(typ. (max.))	V_F	2.1 (≤ 2.8)	V
Reverse current ($V_R = 12\text{ V}$)		I_R	not designed for reverse operation	μA
Radiant intensity ($I_F = 20\text{ mA}$, $t_p = 20\text{ ms}$)	(typ.)	I_e	2.6	mW / sr
Total radiant flux ($I_F = 20\text{ mA}$, $t_p = 20\text{ ms}$)	(typ.)	Φ_e	6.4	mW
Temperature coefficient of $\lambda_{\text{centroid}}$ ($I_F = 20\text{ mA}$, $-10\text{ }^\circ\text{C} \leq T \leq 100\text{ }^\circ\text{C}$)	(typ.)	$\text{TC}_{\lambda_{\text{centroid}}}$	0.13	nm / K

Characteristics ($T_A = 25\text{ °C}$)

Parameter		Symbol	Value	Unit
Green Emitter (single emitter)				
Wavelength of peak emission ($I_F = 20\text{ mA}$)	(typ.)	λ_{peak}	530	nm
Centroid Wavelength ($I_F = 20\text{ mA}$)	(typ. (max.))	$\lambda_{\text{centroid}}$	535 (± 10)	nm
Spectral bandwidth at 50% of I_{max} ($I_F = 20\text{ mA}$)	(typ.)	$\Delta\lambda$	34	nm
Half angle	(typ.)	φ	± 60	°
Rise and fall time of I_e (10% and 90% of $I_{e\text{max}}$) ($I_F = 100\text{ mA}$, $t_p = 16\text{ }\mu\text{s}$, $R_L = 50\text{ }\Omega$)	(typ.)	t_r, t_f	32	ns
Forward voltage ($I_F = 20\text{ mA}$)	(typ. (max.))	V_F	3.2 (≤ 3.70)	V
Reverse current ($V_R = 5\text{ V}$)		I_R	not designed for reverse operation	μA
Radiant intensity ($I_F = 20\text{ mA}$, $t_p = 20\text{ ms}$)	(typ.)	I_e	1.4	mW / sr
Total radiant flux ($I_F = 20\text{ mA}$, $t_p = 20\text{ ms}$)	(typ.)	Φ_e	3.4	mW
Temperature coefficient of $\lambda_{\text{centroid}}$ ($I_F = 20\text{ mA}$, $-10\text{ °C} \leq T \leq 100\text{ °C}$)	(typ.)	$\text{TC}_{\lambda_{\text{centroid}}}$	0.02	nm / K
Temperature coefficient of V_F ($I_F = 20\text{ mA}$, $-10\text{ °C} \leq T \leq 100\text{ °C}$)	(typ.)	TC_V	-4.0	mV / K

Characteristics ($T_A = 25\text{ °C}$)

Parameter		Symbol	Value	Unit
Detector				
Photocurrent ($E_e = 0.1\text{ mW/cm}^2$, $\lambda = 535\text{ nm}$, $V_R = 5\text{ V}$)	(typ.)	$I_{P,535}$	0.42	μA
Photocurrent ($E_e = 0.1\text{ mW/cm}^2$, $\lambda = 655\text{ nm}$, $V_R = 5\text{ V}$)	(typ.)	$I_{P,655}$	0.76	μA
Photocurrent ($E_e = 0.1\text{ mW/cm}^2$, $\lambda = 940\text{ nm}$, $V_R = 5\text{ V}$)	(typ.)	$I_{P,940}$	1.3	μA
Wavelength of max. sensitivity	(typ.)	$\lambda_{S\text{ max}}$	920	nm
Spectral range of sensitivity	(typ.)	$\lambda_{10\%}$	400 ... 1100	nm
Radiation sensitive area	(typ.)	A	1.7	mm^2
Dimensions of radiant sensitive area	(typ.)	L x W	1.3 x 1.3	mm x mm
Dark current ($V_R = 5\text{ V}$, $E_e = 0\text{ mW/cm}^2$)	(typ. (max.))	I_R	1 (≤ 5)	nA
Spectral sensitivity of the chip ($\lambda = 535\text{ nm}$)	(typ.)	$S_{\lambda,535}$	0.27	A / W
Spectral sensitivity of the chip ($\lambda = 655\text{ nm}$)	(typ.)	$S_{\lambda,655}$	0.47	A / W
Spectral sensitivity of the chip ($\lambda = 940\text{ nm}$)	(typ.)	$S_{\lambda,940}$	0.77	A / W
Open-circuit voltage ($E_e = 0.1\text{ mW/cm}^2$, $\lambda = 535\text{ nm}$)	(typ.)	$V_{O,535}$	240	mV
Short-circuit current ($E_e = 0.1\text{ mW/cm}^2$, $\lambda = 535\text{ nm}$)	(typ.)	$I_{SC,535}$	0.40	μA
Open-circuit voltage ($E_e = 0.1\text{ mW/cm}^2$, $\lambda = 655\text{ nm}$)	(typ.)	$V_{O,655}$	250	mV
Short-circuit current ($E_e = 0.1\text{ mW/cm}^2$, $\lambda = 655\text{ nm}$)	(typ.)	$I_{SC,655}$	0.71	μA
Open-circuit voltage ($E_e = 0.1\text{ mW/cm}^2$, $\lambda = 940\text{ nm}$)	(typ.)	$V_{O,940}$	270	mV
Short-circuit current ($E_e = 0.1\text{ mW/cm}^2$, $\lambda = 940\text{ nm}$)	(typ.)	$I_{SC,940}$	1.2	μA

Characteristics ($T_A = 25\text{ °C}$)

Parameter		Symbol	Value	Unit
Rise and fall time ($V_R = 3.3\text{ V}$, $R_L = 50\ \Omega$, $\lambda = 940\text{ nm}$)	(typ.)	t_r, t_f	2.3	μs
Forward voltage ($I_F = 10\text{ mA}$, $E = 0\text{ mW/cm}^2$)	(typ.)	V_F	0.9	V
Capacitance ($V_R = 5\text{ V}$, $f = 1\text{ MHz}$, $E = 0\text{ mW/cm}^2$)	(typ.)	C_0	5	pF

Diagrams for infrared emitter

Relative spectral emission ¹⁾

$I_{rel} = f(\lambda), T_A = 25\text{ }^\circ\text{C}, I_F = 20\text{ mA}$

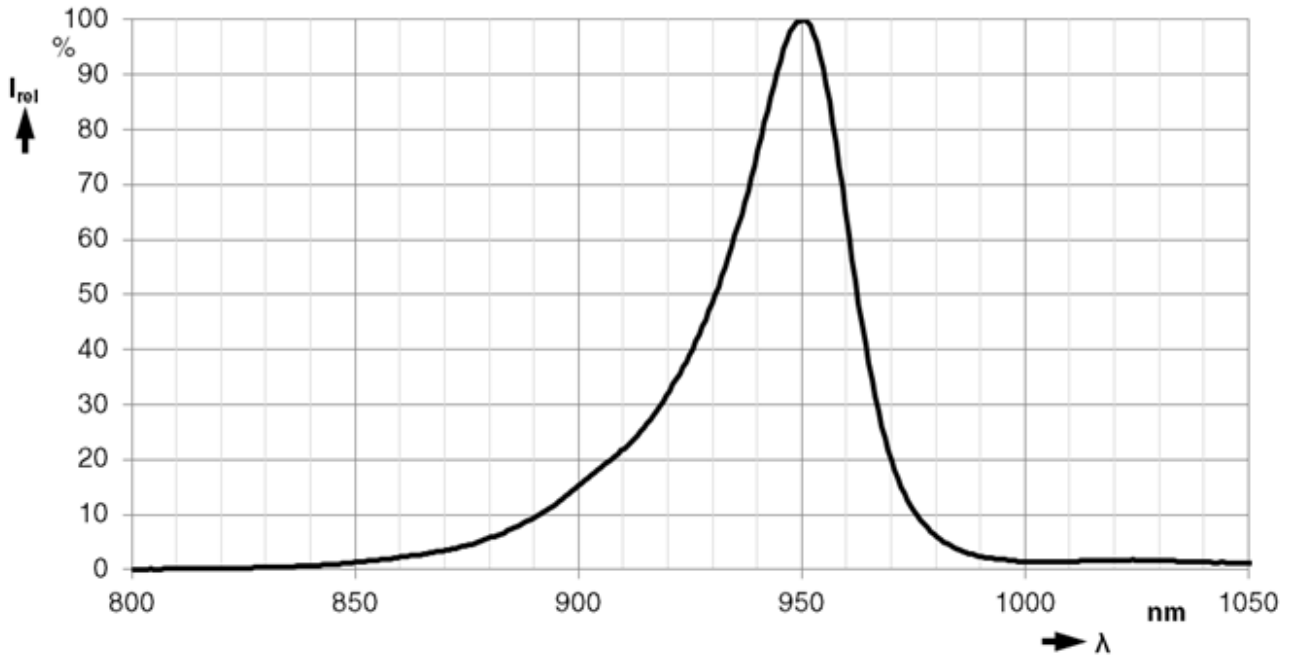

Forward current ¹⁾

$I_F = f(V_F), \text{ single pulse, } t_p = 100\text{ }\mu\text{s}, T_A = 25\text{ }^\circ\text{C}$

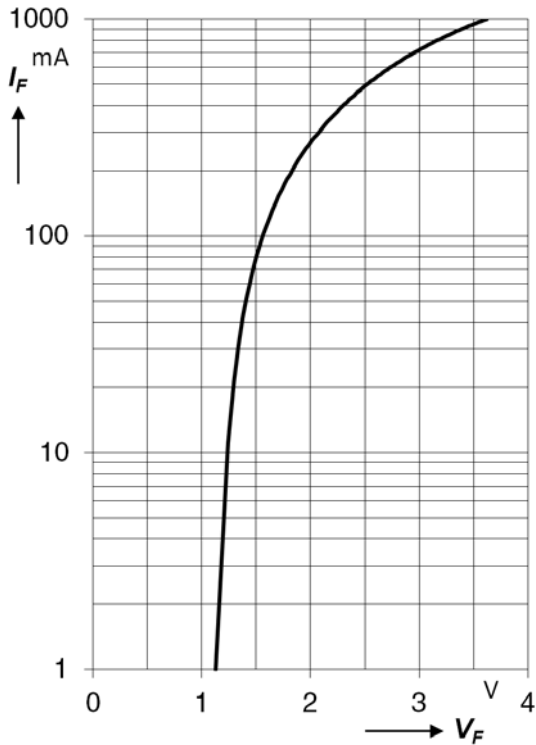

Relative radiant flux ¹⁾

$\Phi_e / \Phi_e(20\text{ mA}) = f(I_F), \text{ single pulse, } t_p = 25\text{ }\mu\text{s}, T_A = 25\text{ }^\circ\text{C}$

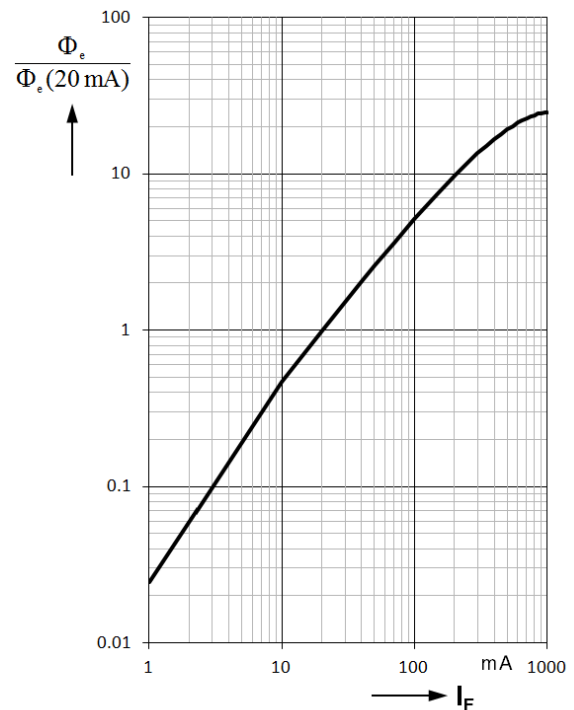

Diagrams for infrared emitter

Max. permissible forward current ¹⁾

$I_{F,max} = f(T_A), R_{thJA} = 800 \text{ K/W}$

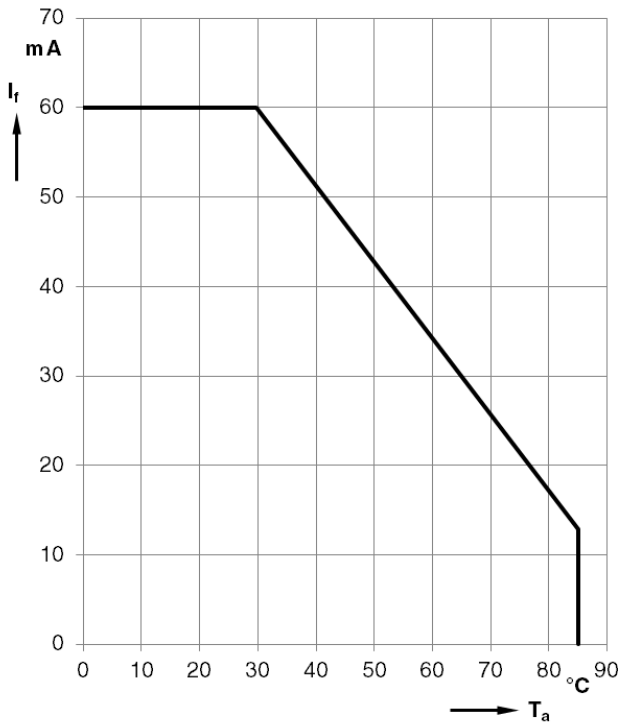

Permissible pulse handling capability ¹⁾

$I_F = f(t_p), T_A = 40^\circ\text{C}, \text{duty cycle } D = \text{parameter}$

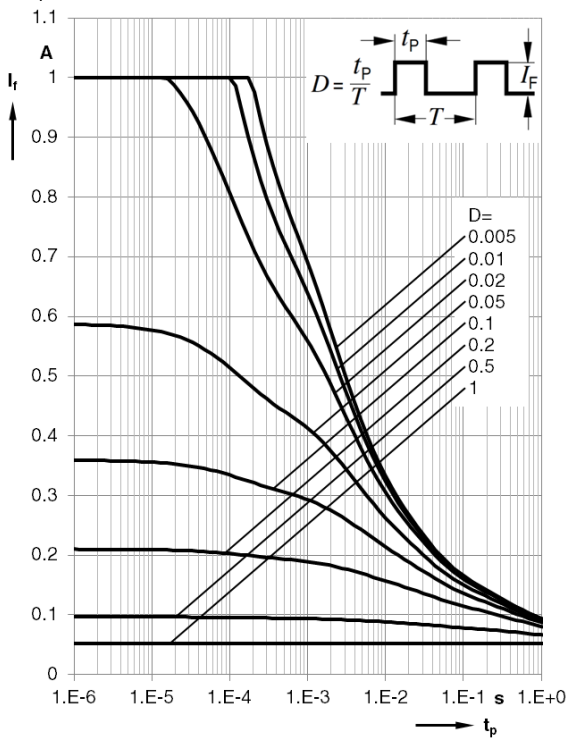

Permissible pulse handling capability ¹⁾

$I_F = f(t_p), T_A = 85^\circ\text{C}, \text{duty cycle } D = \text{parameter}$

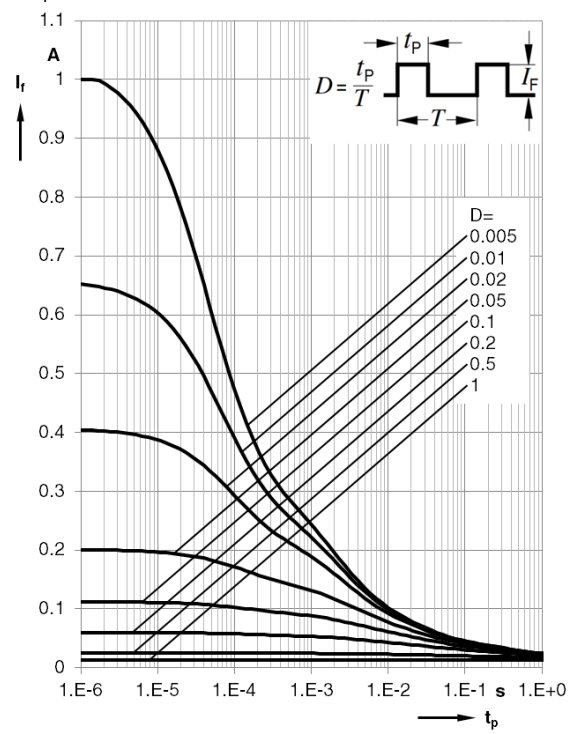

Diagrams for red emitter

Relative spectral emission ¹⁾

$I_{rel} = f(\lambda), T_A = 25\text{ }^\circ\text{C}, I_F = 20\text{ mA}$

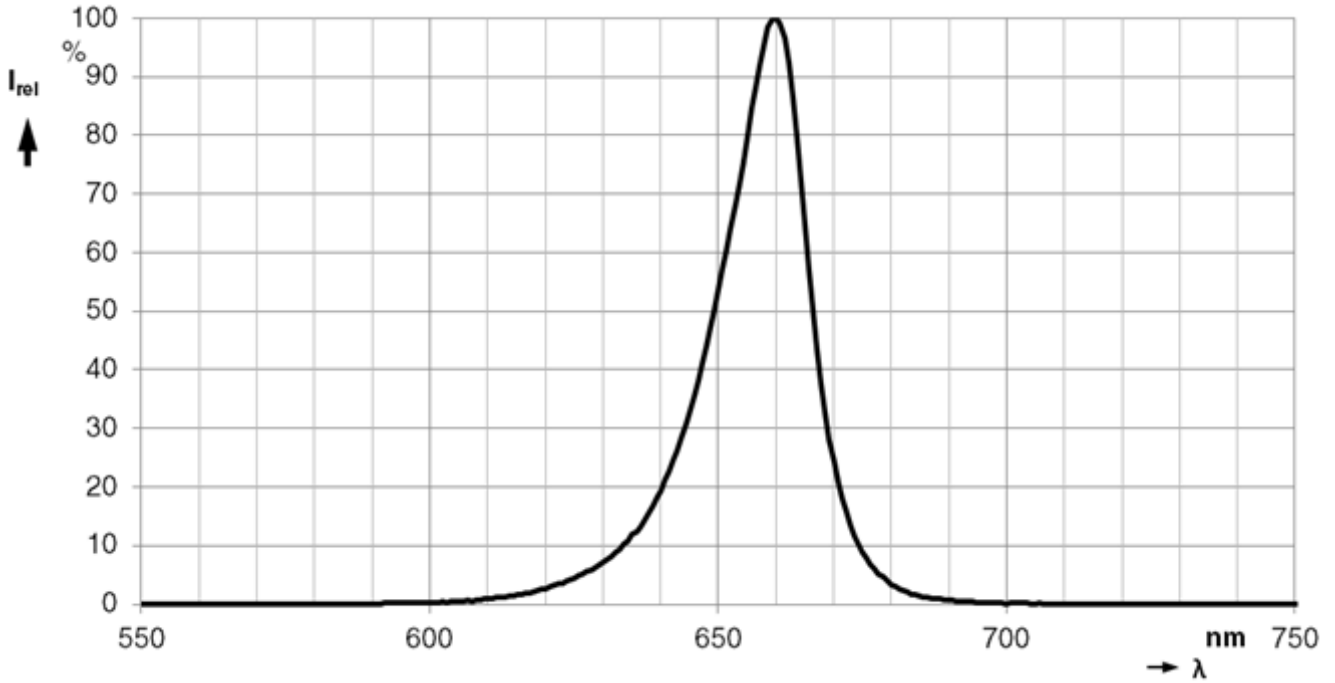

Forward current ¹⁾

$I_F = f(V_F), T_A = 25\text{ }^\circ\text{C}$

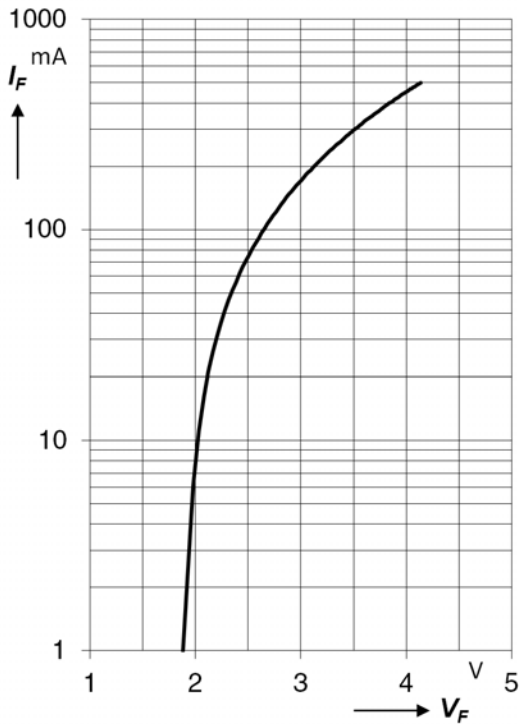

Relative radiant flux ¹⁾

$\Phi_e / \Phi_e(20\text{ mA}) = f(I_F), \text{ single pulse, } t_p = 25\mu\text{s}, T_A = 25\text{ }^\circ\text{C}$

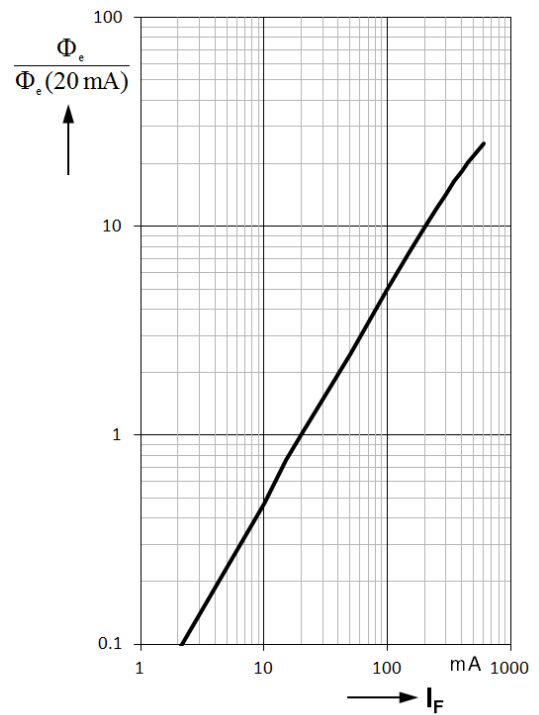

Diagrams for red emitter

Max. permissible forward current ¹⁾

$I_{F,max} = f(T_A), R_{thJA} = 800 \text{ K/W}$

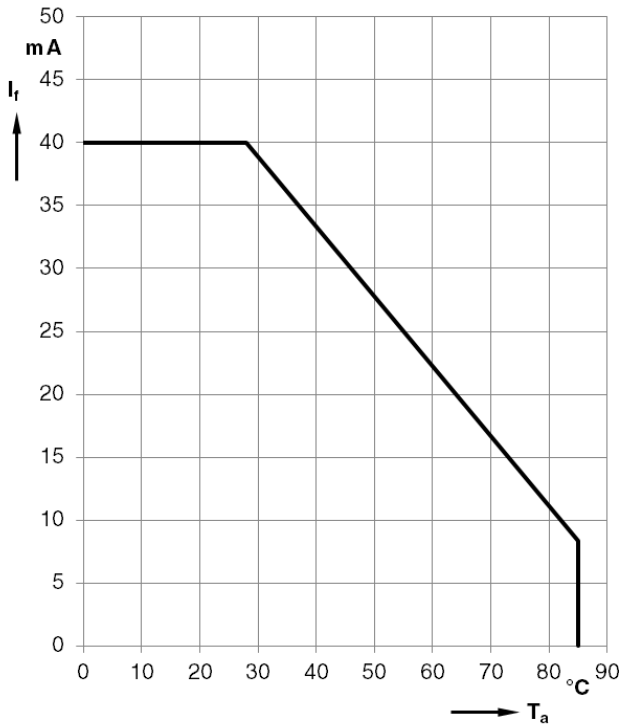

Permissible pulse handling capability ¹⁾

$I_F = f(t_p), T_A = 40^\circ\text{C}, \text{ duty cycle } D = \text{parameter}$

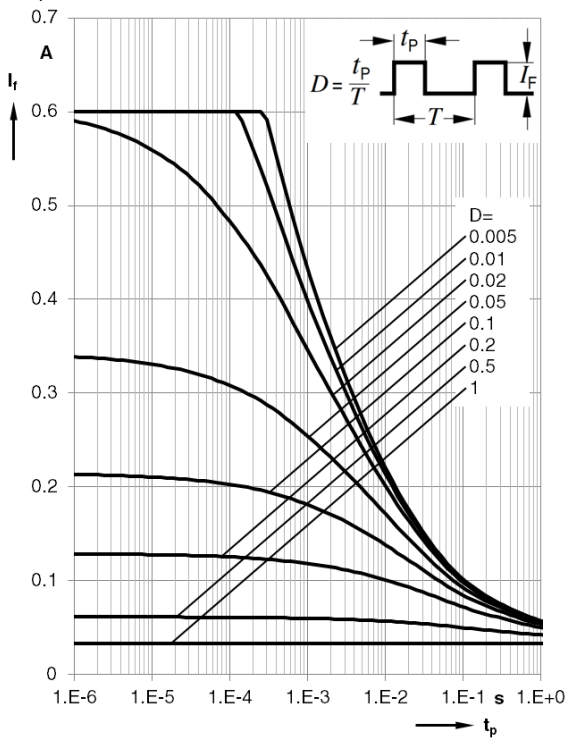

Permissible pulse handling capability ¹⁾

$I_F = f(t_p), T_A = 85^\circ\text{C}, \text{ duty cycle } D = \text{parameter}$

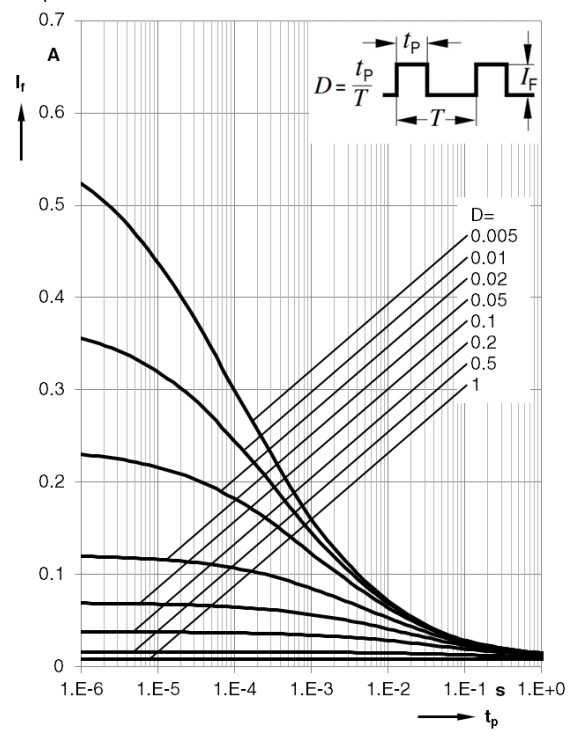

Diagrams for green emitters

Relative spectral emission ¹⁾

$I_{rel} = f(\lambda), T_A = 25\text{ }^\circ\text{C}, I_F = 20\text{ mA}$

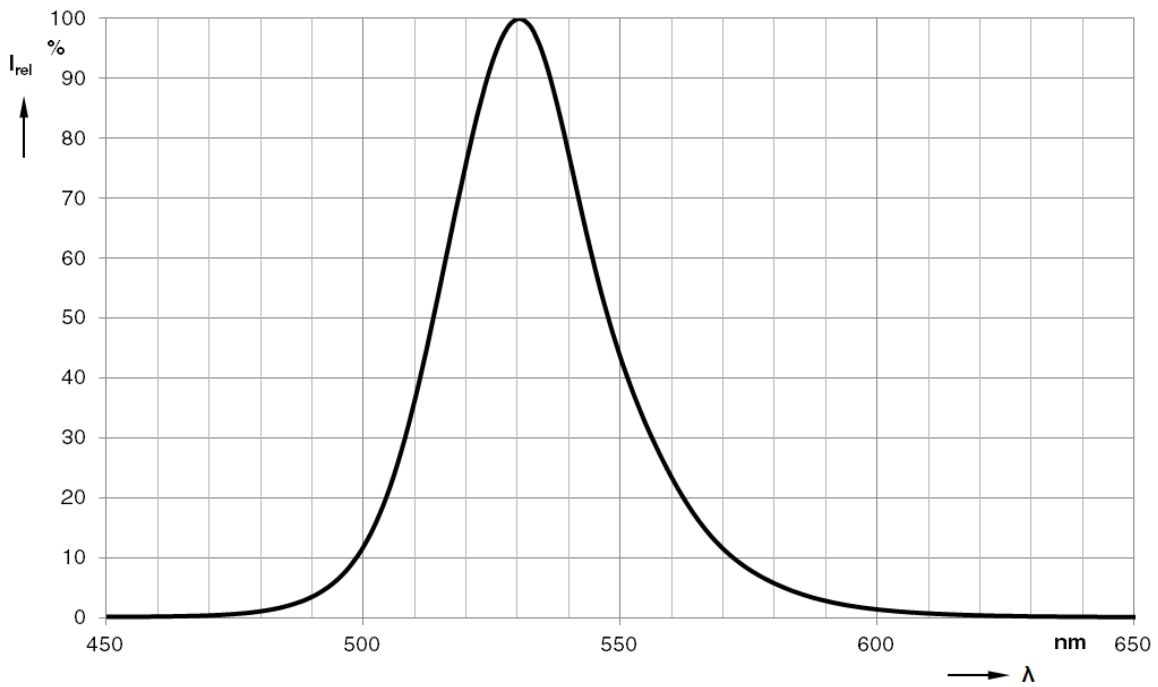

Forward current ¹⁾

$I_F = f(V_F), T_A = 25\text{ }^\circ\text{C}$

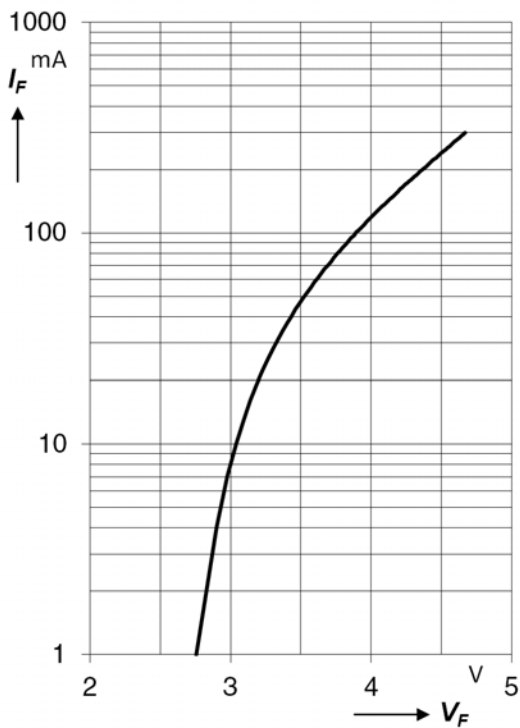

Relative radiant flux ¹⁾

$\Phi_e / \Phi_e(20\text{ mA}) = f(I_F), \text{ single pulse, } t_p = 25\mu\text{s}, T_A = 25\text{ }^\circ\text{C}$

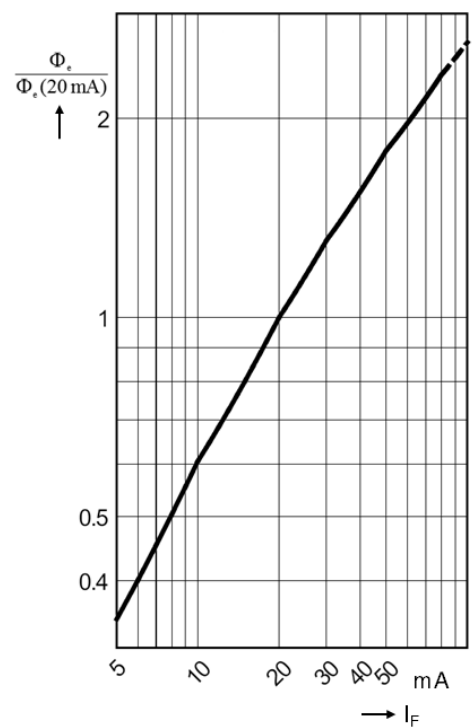

Diagrams for green emitters

Max. permissible forward current ¹⁾

(single emitter) $I_{F,max} = f(T_A)$, $R_{thJA} = 800 \text{ K/W}$

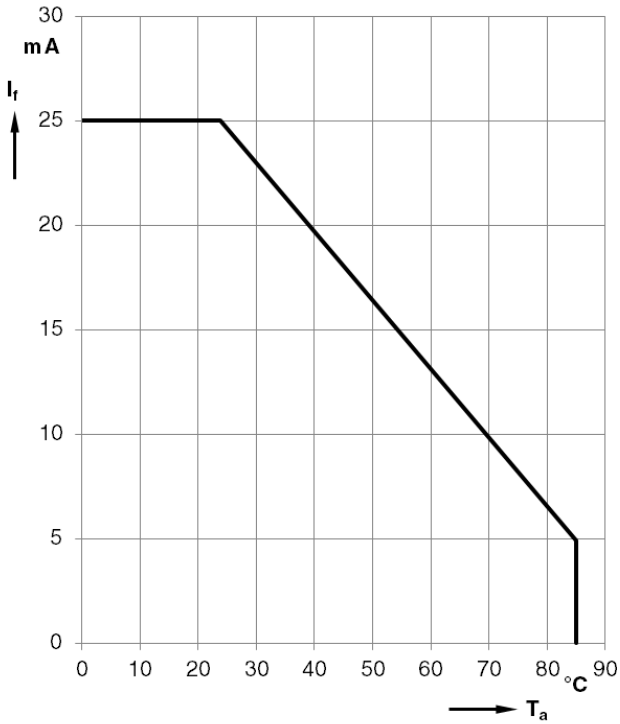

Permissible pulse handling capability ¹⁾

(single emitter) $I_F = f(t_p)$, $T_A = 40^\circ\text{C}$, duty cycle D

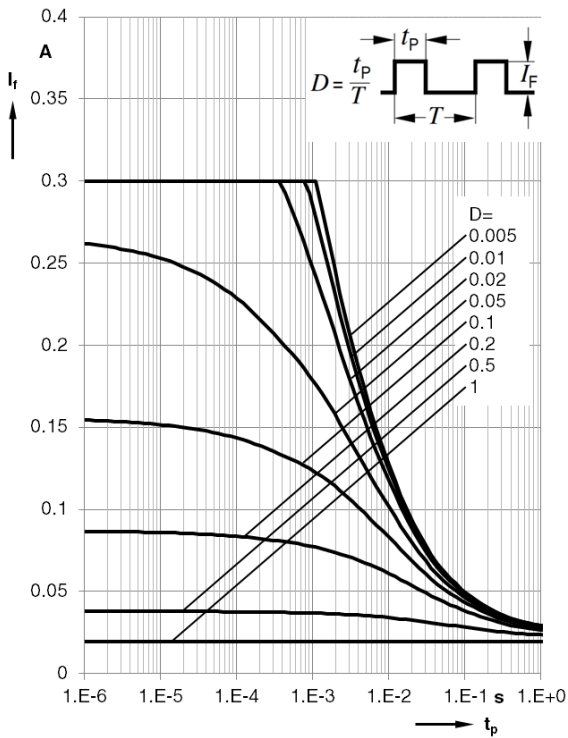

Permissible pulse handling capability ¹⁾

(single emitter) $I_F = f(t_p)$, $T_A = 85^\circ\text{C}$, duty cycle D

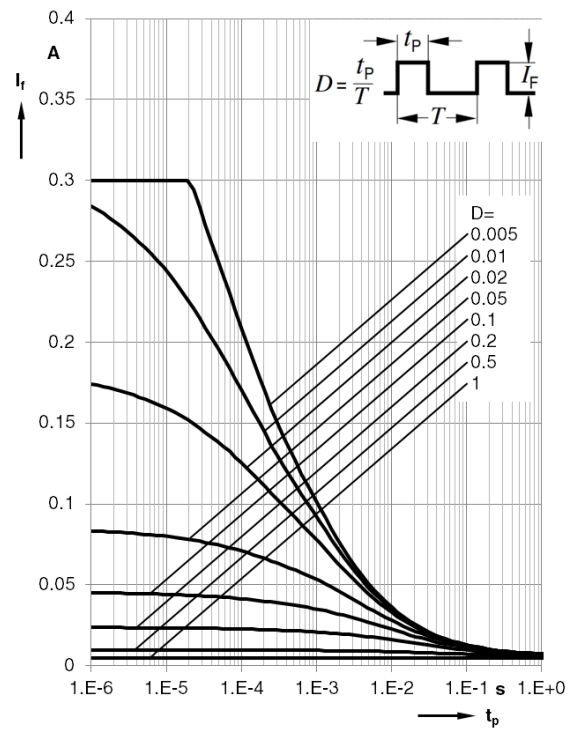

Diagrams for green emitters

Max. permissible forward current ¹⁾
 (three emitters) $I_{F,max} = f(T_A)$, $R_{thJA} = 800 \text{ K/W}$

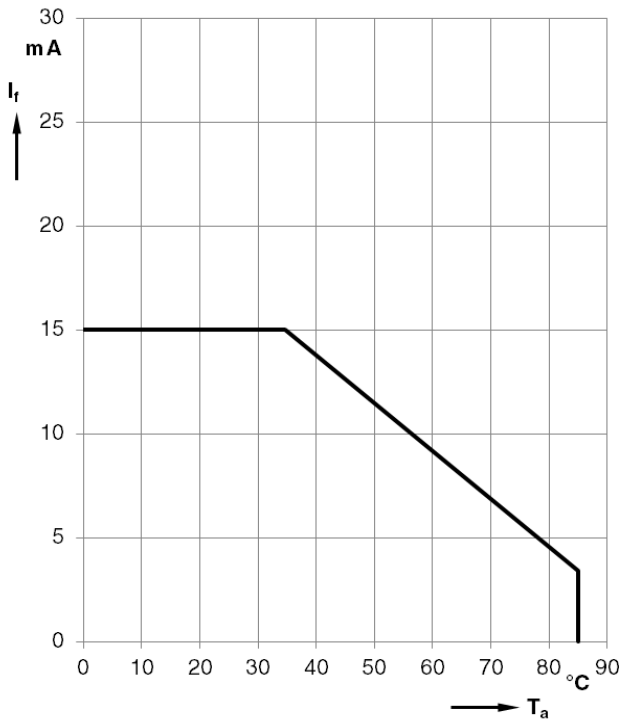

Permissible pulse handling capability ¹⁾
 (three emitters) $I_F = f(t_p)$, $T_A = 40^\circ\text{C}$, duty cycle D

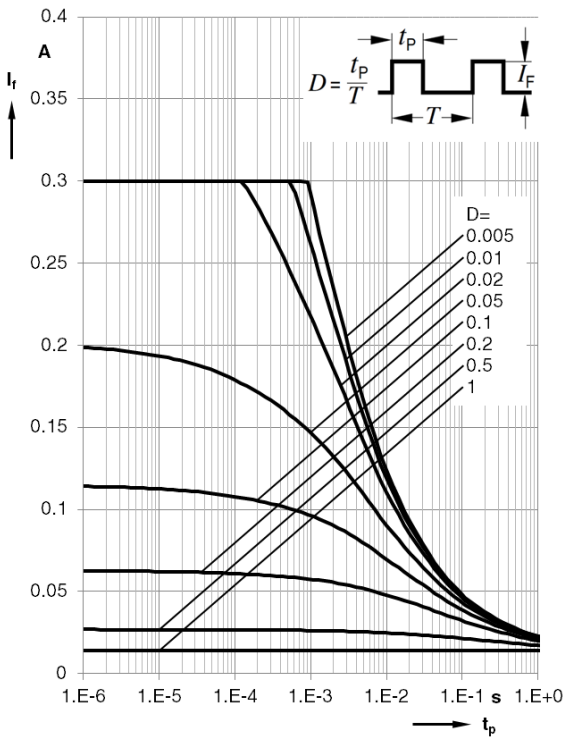

Permissible pulse handling capability ¹⁾
 (three emitters) $I_F = f(t_p)$, $T_A = 85^\circ\text{C}$, duty cycle D

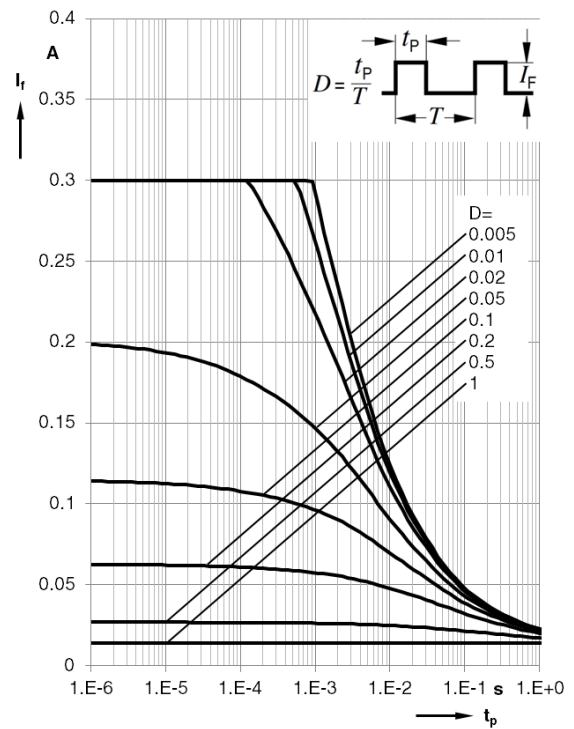

Diagrams for detector

Relative spectral sensitivity ¹⁾

$S_{rel} = f(\lambda), T_A = 25\text{ °C}$

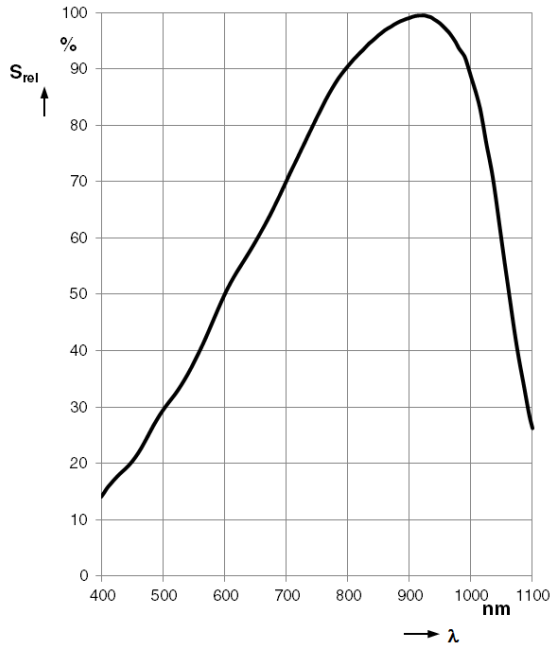

Photocurrent ¹⁾

$I_P(V_R = 5\text{ V}), T_A = 25\text{ °C}$

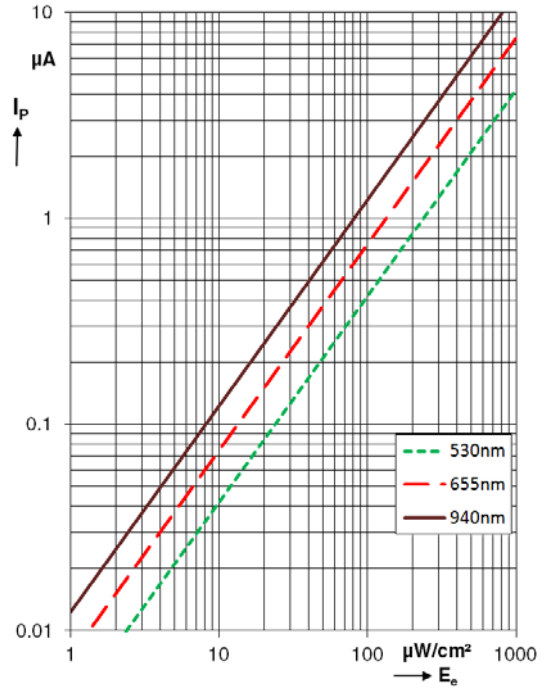

Dark current ¹⁾

$I_R = f(V_R), E = 0\text{ mW/cm}^2, T_A = 25\text{ °C}$

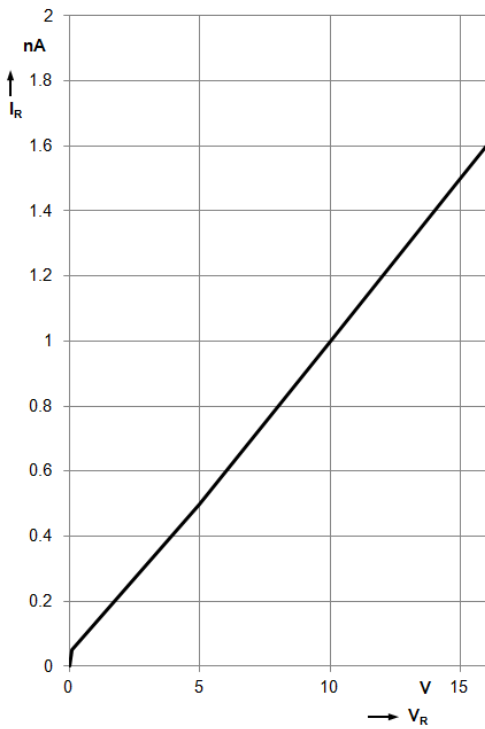

Capacitance ¹⁾

$C = f(V_R), f = 1\text{ MHz}, E = 0\text{ mW/cm}^2, T_A = 25\text{ °C}$

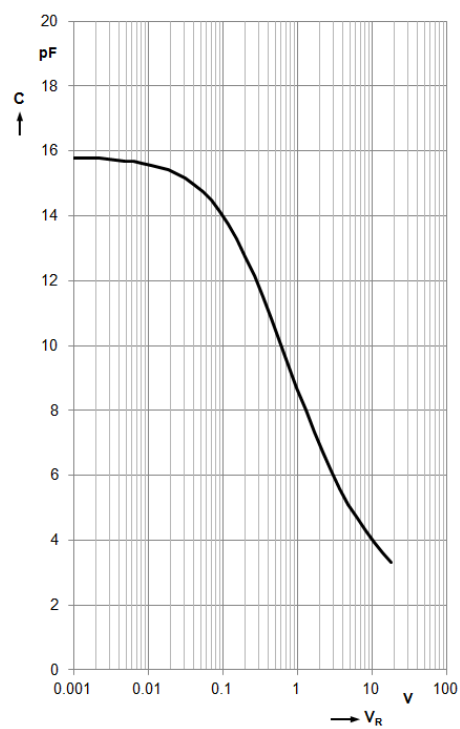

Directional characteristics of detector ¹⁾

$S_{rel} = f(\varphi)$

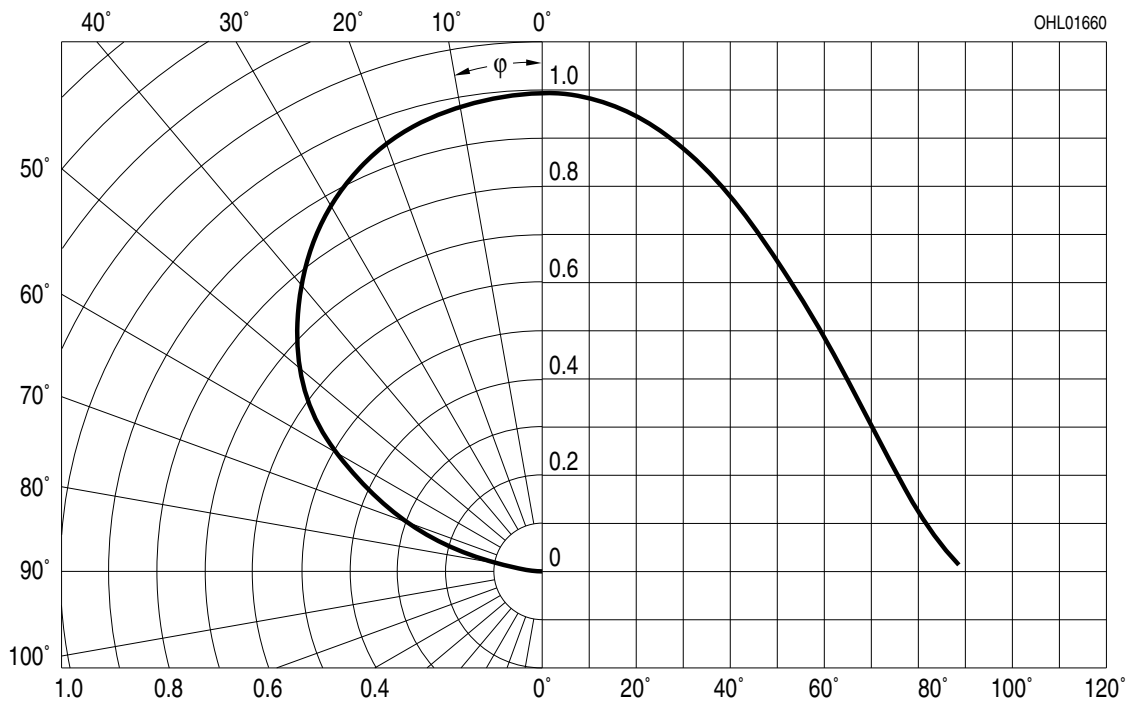

Radiation characteristics of emitters ¹⁾

$I_{rel} = f(\varphi)$

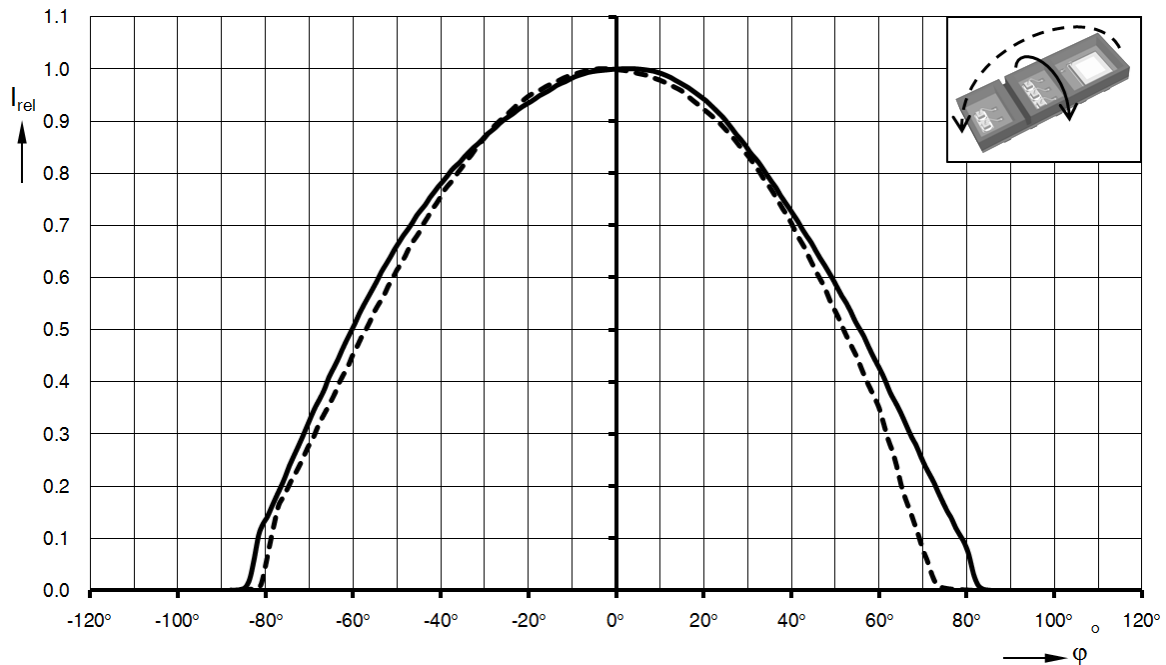

Method of Taping

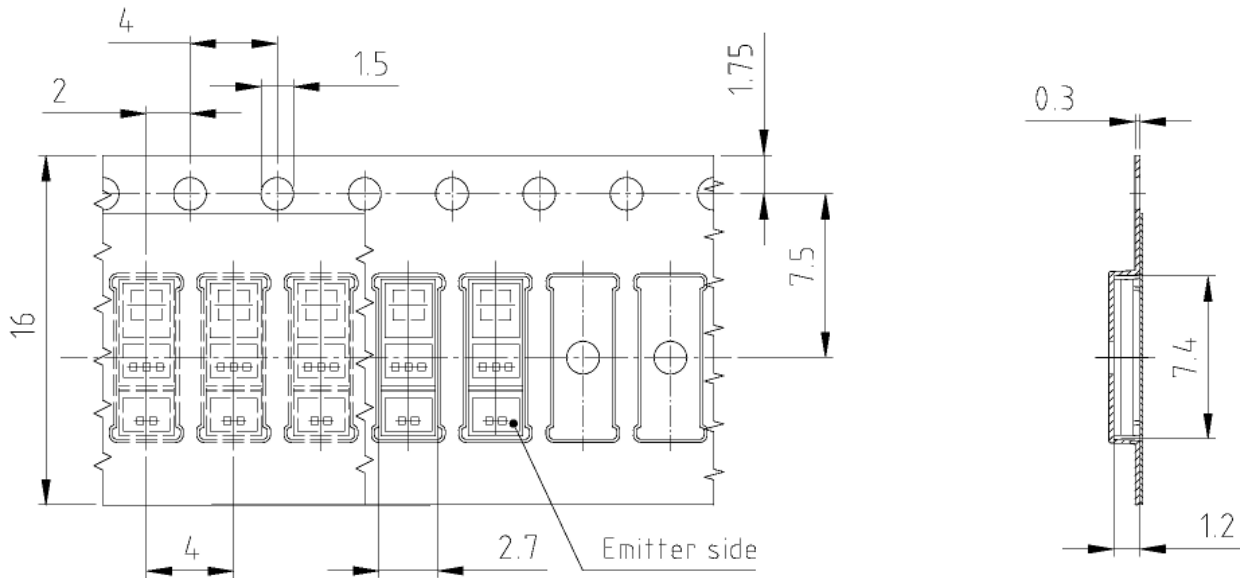

C63062-A4289-B6 -02

Dimensions in mm [inch]. / Maße in mm [inch].

Recommended solder pad design

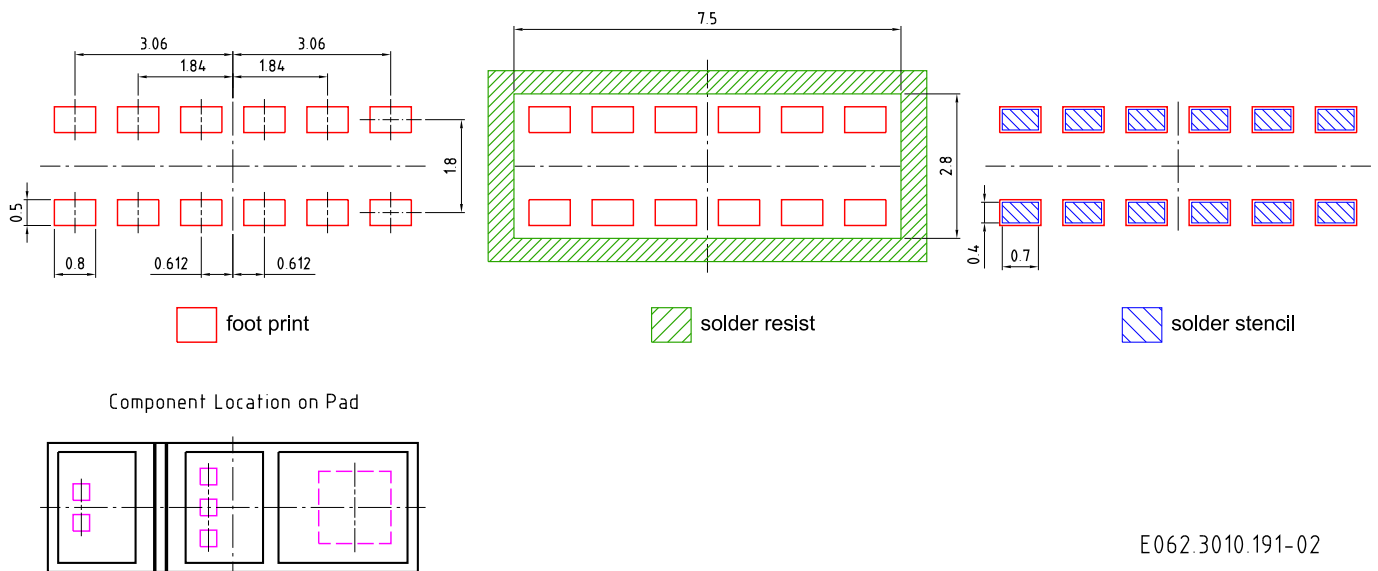

E062.3010.191-02

Dimensions in mm (inch). / Maße in mm (inch).

Package Outline

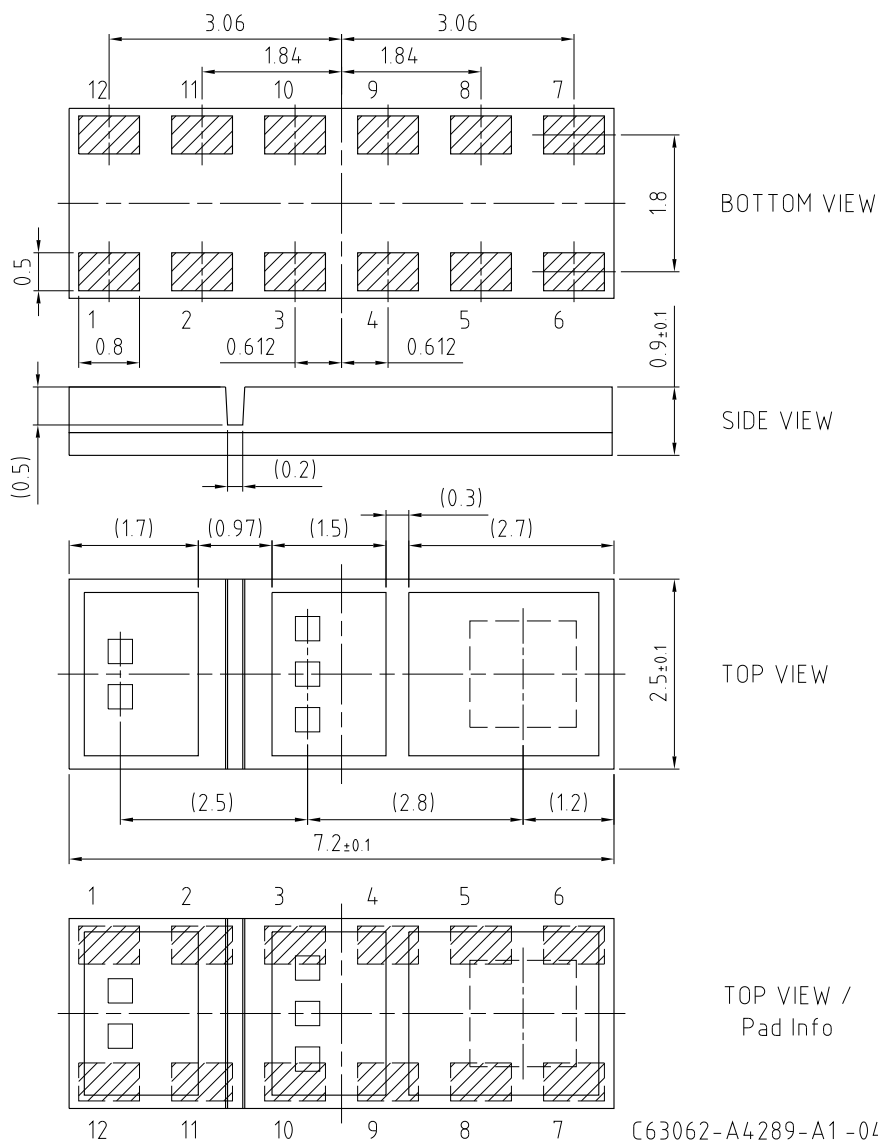

Pin	Name	Function
1	RA	Red LED Anode
2	RC	RED LED Cathode
3	G1C	Green LED 1 Cathode
4	G1A	Green LED 1 Anode
5	G2A	Green LED 2 Anode
6	PA	Photodiode Anode
7	PC	Photodiode Cathode
8	G2C	Green LED 2 Cathode
9	G3A	Green LED 3 Anode
10	G3C	Green LED 3 Cathode
11	IC	Infrared LED Cathode
12	IA	Infrared LED Anode

Dimensions in mm / Maße in mm.

Package: chip on board

Reflow Soldering Profile

Product complies to MSL Level 4 acc. to JEDEC J-STD-020D.01

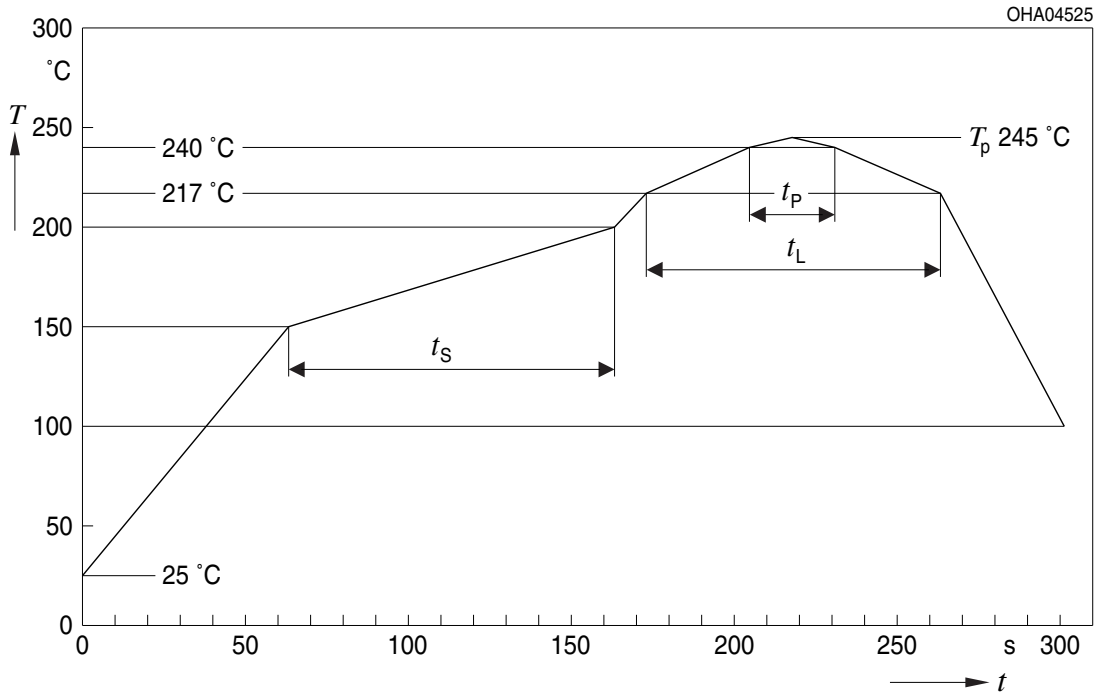

OHA04612

Profile Feature Profil-Charakteristik	Symbol Symbol	Pb-Free (SnAgCu) Assembly			Unit Einheit
		Minimum	Recommendation	Maximum	
Ramp-up rate to preheat*) 25 °C to 150 °C			2	3	K/s
Time t_s T_{Smin} to T_{Smax}	t_s	60	100	120	s
Ramp-up rate to peak*) T_{Smax} to T_p			2	3	K/s
Liquidus temperature	T_L	217			°C
Time above liquidus temperature	t_L		80	100	s
Peak temperature	T_p		245	260	°C
Time within 5 °C of the specified peak temperature $T_p - 5$ K	t_p	10	20	30	s
Ramp-down rate* T_p to 100 °C			3	6	K/s
Time 25 °C to T_p				480	s

All temperatures refer to the center of the package, measured on the top of the component
 * slope calculation DT/Dt : Dt max. 5 s; fulfillment for the whole T-range

Disclaimer

OSRAM OS assumes no liability whatsoever for any use of this document or its content by recipient including, but not limited to, for any design in activities based on this preliminary draft version. OSRAM OS may e.g. decide at its sole discretion to stop developing and/or finalizing the underlying design at any time.

Language english will prevail in case of any discrepancies or deviations between the two language wordings.

Attention please!

The information describes the type of component and shall not be considered as assured characteristics. Terms of delivery and rights to change design reserved. Due to technical requirements components may contain dangerous substances.

For information on the types in question please contact our Sales Organization. If printed or downloaded, please find the latest version in the Internet.

Packing

Please use the recycling operators known to you. We can also help you – get in touch with your nearest sales office. By agreement we will take packing material back, if it is sorted. You must bear the costs of transport. For packing material that is returned to us unsorted or which we are not obliged to accept, we shall have to invoice you for any costs incurred.

Components used in life-support devices or systems must be expressly authorized for such purpose!

Critical components* may only be used in life-support devices** or systems with the express written approval of OSRAM OS.

*) A critical component is a component used in a life-support device or system whose failure can reasonably be expected to cause the failure of that life-support device or system, or to affect its safety or the effectiveness of that device or system.

**) Life support devices or systems are intended (a) to be implanted in the human body, or (b) to support and/or maintain and sustain human life. If they fail, it is reasonable to assume that the health and the life of the user may be endangered.

Disclaimer

OSRAM OS übernimmt keine wie auch immer geartete Haftung für die Nutzung dieses Dokuments und seines Inhaltes durch den Empfänger, insbesondere nicht für irgendwelche Design-Aktivitäten, die auf dieser vorläufigen Entwurfsversion basieren. OSRAM OS behält sich beispielsweise auch vor, jederzeit die Weiter- und Fertigungsentwicklung des zugrundeliegenden Designs einseitig einzustellen.

Bei abweichenden Angaben im zweisprachigen Wortlaut haben die Angaben in englischer Sprache Vorrang.

Bitte beachten!

Lieferbedingungen und Änderungen im Design vorbehalten. Aufgrund technischer Anforderungen können die Bauteile Gefahrstoffe enthalten. Für weitere Informationen zu gewünschten Bauteilen, wenden Sie sich bitte an unseren Vertrieb. Falls Sie dieses Datenblatt ausgedruckt oder heruntergeladen haben, finden Sie die aktuellste Version im Internet.

Verpackung

Benutzen Sie bitte die Ihnen bekannten Recyclingwege. Wenn diese nicht bekannt sein sollten, wenden Sie sich bitte an das nächstgelegene Vertriebsbüro. Wir nehmen das Verpackungsmaterial zurück, falls dies vereinbart wurde und das Material sortiert ist. Sie tragen die Transportkosten. Für Verpackungsmaterial, das unsortiert an uns zurückgeschickt wird oder das wir nicht annehmen müssen, stellen wir Ihnen die anfallenden Kosten in Rechnung.

Bauteile, die in lebenserhaltenden Apparaten und Systemen eingesetzt werden, müssen für diese Zwecke ausdrücklich zugelassen sein!

Kritische Bauteile* dürfen in lebenserhaltenden Apparaten und Systemen** nur dann eingesetzt werden, wenn ein schriftliches Einverständnis von OSRAM OS vorliegt.

*) Ein kritisches Bauteil ist ein Bauteil, das in lebenserhaltenden Apparaten oder Systemen eingesetzt wird und dessen Defekt voraussichtlich zu einer Fehlfunktion dieses lebenserhaltenden Apparates oder Systems führen wird oder die Sicherheit oder Effektivität dieses Apparates oder Systems beeinträchtigt.

**) Lebenserhaltende Apparate oder Systeme sind für (a) die Implantierung in den menschlichen Körper oder (b) für die Lebenserhaltung bestimmt. Falls Sie versagen, kann davon ausgegangen werden, dass die Gesundheit und das Leben des Patienten in Gefahr ist.

Glossary

¹⁾ **Typical Values:** Due to the special conditions of the manufacturing processes of LED and photodiodes, the typical data or calculated correlations of technical parameters can only reflect statistical figures. These do not necessarily correspond to the actual parameters of each single product, which could differ from the typical data and calculated correlations or the typical characteristic line. If requested, e.g. because of technical improvements, these typ. data will be changed without any further notice.

Glossar

¹⁾ **Typische Werte:** Wegen der besonderen Prozessbedingungen bei der Herstellung von LED und Photodioden können typische oder abgeleitete technische Parameter nur aufgrund statistischer Werte wiedergegeben werden. Diese stimmen nicht notwendigerweise mit den Werten jedes einzelnen Produktes überein, dessen Werte sich von typischen und abgeleiteten Werten oder typischen Kennlinien unterscheiden können. Falls erforderlich, z.B. aufgrund technischer Verbesserungen, werden diese typischen Werte ohne weitere Ankündigung geändert.

Published by OSRAM Opto Semiconductors GmbH
Leibnizstraße 4, D-93055 Regensburg
www.osram-os.com © All Rights Reserved.

EU RoHS and China RoHS compliant product



此产品符合欧盟 RoHS 指令的要求；
按照中国的相关法规和标准，不含有毒有害物质或元素。