

REV	CHANGE	DATE	DRN	CHK
	Drawn	02/23/17	SJ	T

TOLERANCE DETAILS		
1	A	+ 0.020 [+0.50] - 0.000 [-0.00]
2	B	±0.015 [±0.40]
3	C	±0.015 [±0.40]
4	D	±0.010 [±0.30]

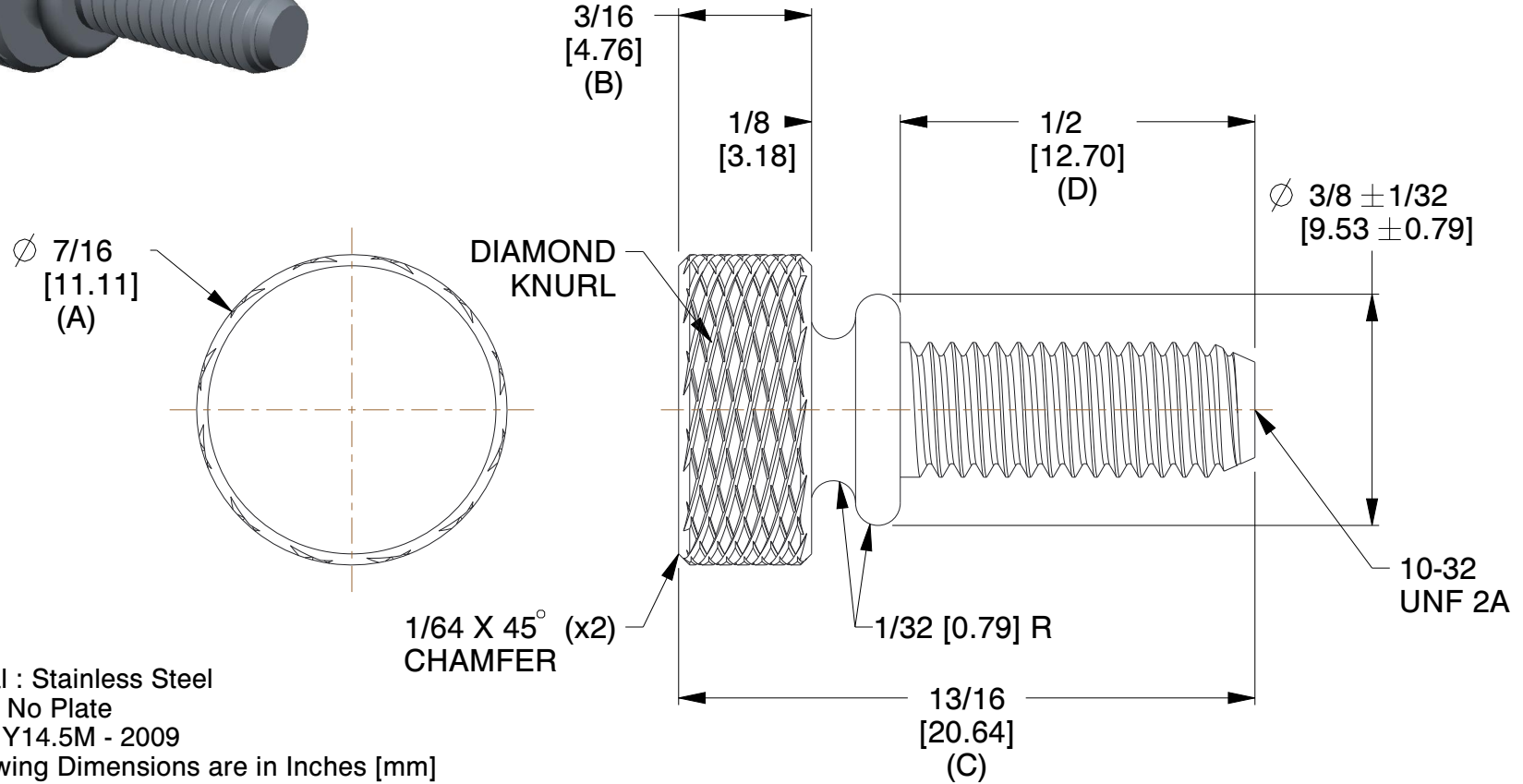
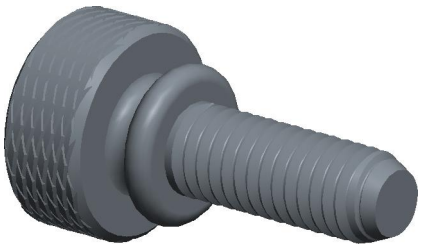

**NOTES:**

1. Material : Stainless Steel
2. Finish : No Plate
3. ASME Y14.5M - 2009
4. All Drawing Dimensions are in Inches [mm]
5. Unless otherwise specified; Edge Breaks, Radii or Countersinks 0.005-0.015



95 Silvermine Rd., Seymour CT 06483  
Tel: 203-888-2133, Fax: 203-888-9860

This Drawing is the Property of RAF. It contains confidential, proprietary information that is RAF property. Do not disclose to or duplicate for others except as authorized by RAF.

**TOLERANCES**  
ALL DIMENSIONS ARE INCHES (UNLESS OTHERWISE SPECIFIED)  
**METALLIC**  
LENGTHS < 6 INCHES ± 0.005  
LENGTH > 6 INCHES ± 0.010  
DIAMETERS: ± 0.005  
**NON-METALLIC**  
LENGTH: ± 0.010 DIAMETERS: ± 0.010  
**INTERNAL THREADS:**  
MINIMUM THREAD DEPTH

COMPONENT	THUMB SCREWS
<b>7110-SS</b>	<b>SCALE</b>
	4.00
	<b>SHEET</b>
WASHER FACE THUMB SCREWS	1 of 1