

SECTION B-B

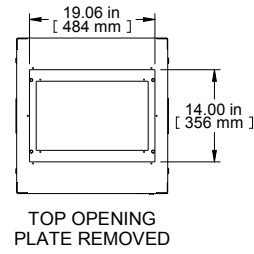

TOP OPENING PLATE REMOVED

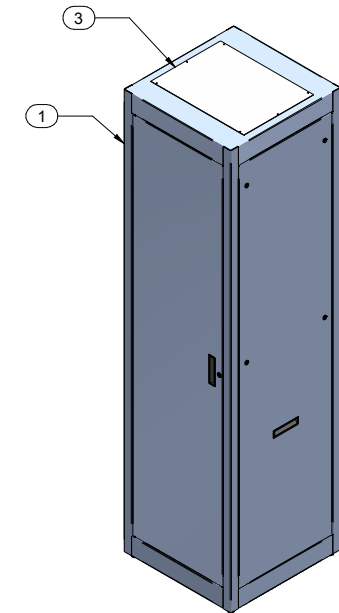

ISOMETRIC

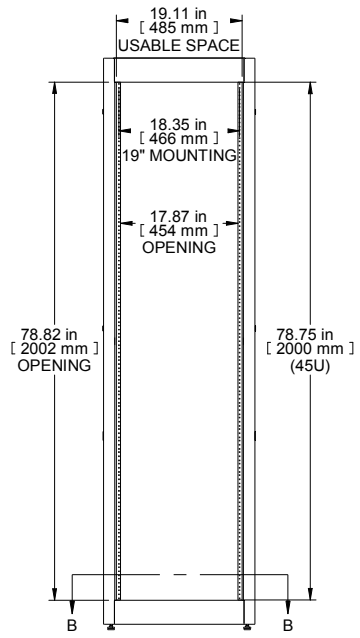

FRONT VIEW DOOR REMOVED

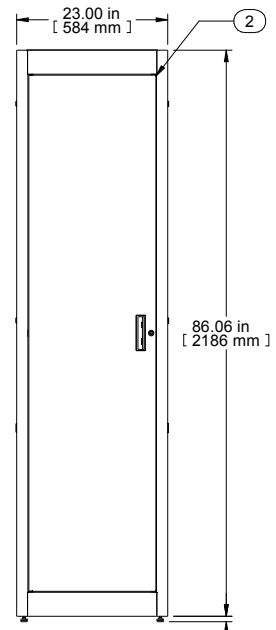

FRONT VIEW

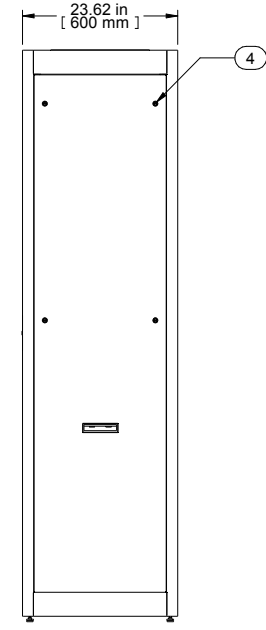

R.S. VIEW

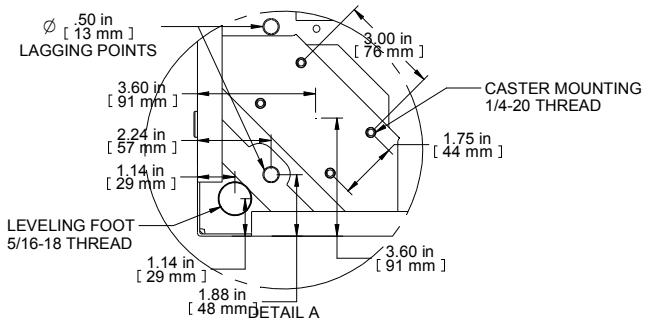

DETAIL A

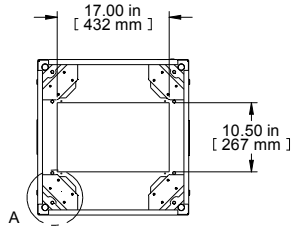

BOTTOM VIEW BOTTOM OPENING

Item Number	Title	Quantity
1	C2 - CABINET FRAME	1
2	C2 - FLUSH SOLID DOOR	1
3	C2 SOLID TOP PANEL	1
4	C2 - SOLID SIDE PANEL (PAIR)	1
5	TAPPED COMBINATION RAIL (PAIR)	2

PART NUMBERS

C2RR197823BK1	PAINTED BLACK TEXTURE
C2RR197823LG1	PAINTED LIGHT GRAY TEXTURE

NOTES

C2 Series Rapid Rack Assembly
See Hammond Website for Frame Accessories

Data subject to change without notice. Isometric drawing not to scale.
Les données sont sujettes à changement sans préavis.



www.hammondmgf.com

PART NO. C2RR197823