

ISL76683 Light-to-Digital Output Sensor Evaluation Hardware/Software User Guide

Description

The ISL76683EVAL1Z evaluation board is an RoHS compliant evaluation board designed for exploring the operation of the ISL76683 light-to-digital output sensor. The evaluation board is an easy-to-use platform for testing most of the specifications and functionalities described in the [ISL76683 datasheet](#).

Evaluation Package

- Demo Board (Evaluation Board ISL76683EVAL1Z and USB Board ISLUSBCEVAL1Z, REV A), populated with all required components
- USB 2.0 Cable
- Evaluation Software (see [“Tools and Support”](#) on [ISL76683 device information page](#))
- AN1657: “ISL76683 Light-to-Digital Output Sensor Evaluation Hardware/Software User Guide” (see [“Technical Documentation”](#) on [ISL76683 device information page](#))

System Requirements

- Windows 98/NT/2000/XP
- USB Port

Hardware Setup

The PC and printed circuit board (PCB) should not be connected via the USB until after the evaluation software has been installed satisfactorily (see “Software Setup” on page 2).

To set up the hardware:

1. Connect the USB 2.0 cable first to the PC and then to the evaluation board. The USB cable is the only connector needed.
2. If a dialog appears asking about installing software for new-found hardware, click “Yes, this time only”.

The jumpers on the printed circuit board (PCB) are as shown in Table 1.

TABLE 1. JUMPERS ON PCB

| JUMPER | DESCRIPTION |
|-------------|--------------------------|
| J500K | Rext = 500kΩ |
| J100K | Rext = 100kΩ (Default) |
| J50K | Rext = 50kΩ |
| VDD to 3.3V | Connect 3.3V rail to VDD |

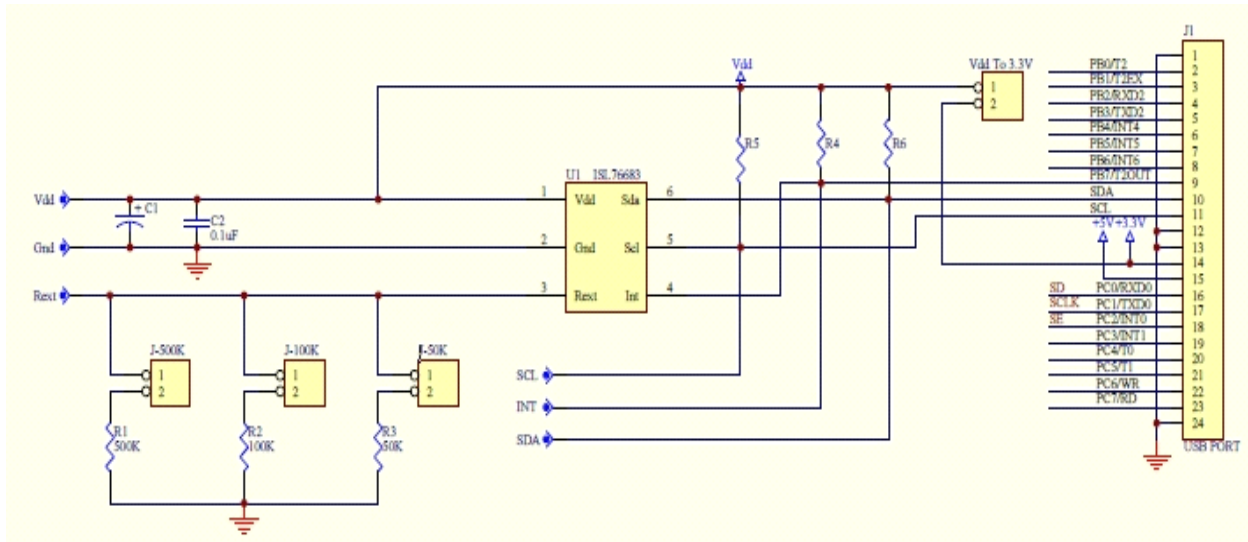

FIGURE 1. ISL76683EVAL1Z EVALUATION BOARD SCHEMATIC

Software Setup

Downloading the Software

On the [ISL76683 device information page](#), under “Tools and Support”, click [Intersil_ALS_ISL76683_Installer_V100.exe](#) to download the ISL76683 evaluation software installer file.

Firmware Reference

The installer file has Human Interface Device (HID) firmware in the microcontroller board, ISLUSBCEVAL1Z, REV A. The firmware allows the evaluation software to communicate with the ISL76683 evaluation board through a PC operating on Windows 98/NT/2000/XP.

Installing the Software

Download and run [Intersil_ALS_ISL76683_Installer_V100.exe](#). The dialog shown in Figure 2 appears. Follow the instructions on each screen for installing the software. The PC and PCB should not be connected via the USB until after the installation has completed satisfactorily.

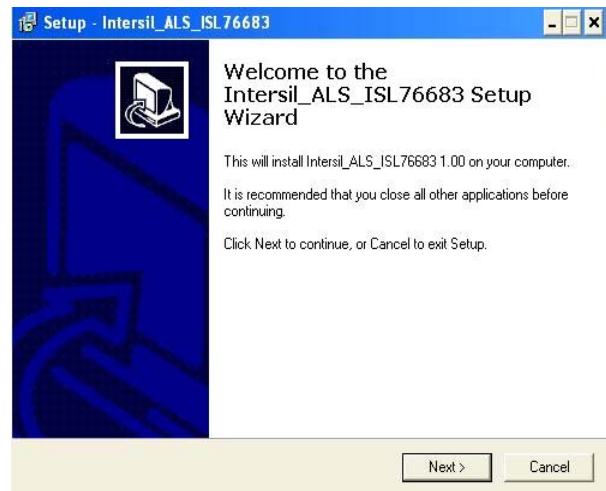

FIGURE 2. SOFTWARE SETUP WIZARD

Running the Evaluation Software

To open the evaluation software program:

1. Click the **Start** menu and navigate to the software as follows: **Start -> All Programs -> Intersil -> Intersil_ALS_ISL76683 -> Intersil_ALS_ISL76683**.
2. Double-click the program name. The **Intersil Light Sensor Demo...** window shown in Figure 3 appears.
3. In the **Device Select** dropdown menu, select **ISL76683**.
4. The **ISL76683 Light Sensor Evaluation Software** window shown in Figure 4 opens. This window is the main interface for demonstrating the capabilities of ISL76683.

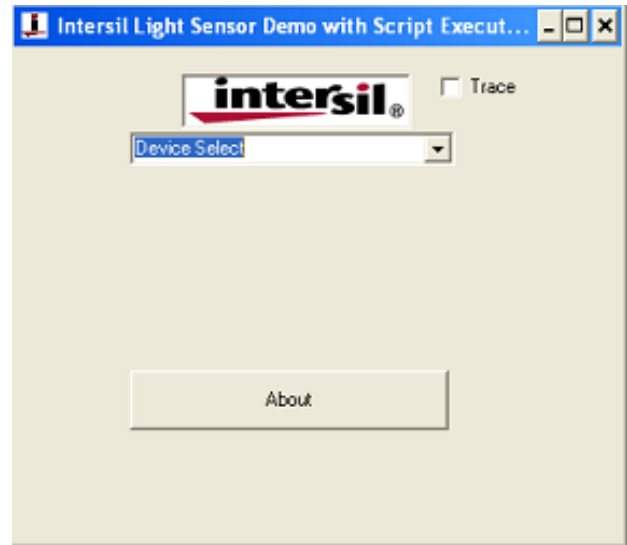

FIGURE 3. SOFTWARE STARTUP

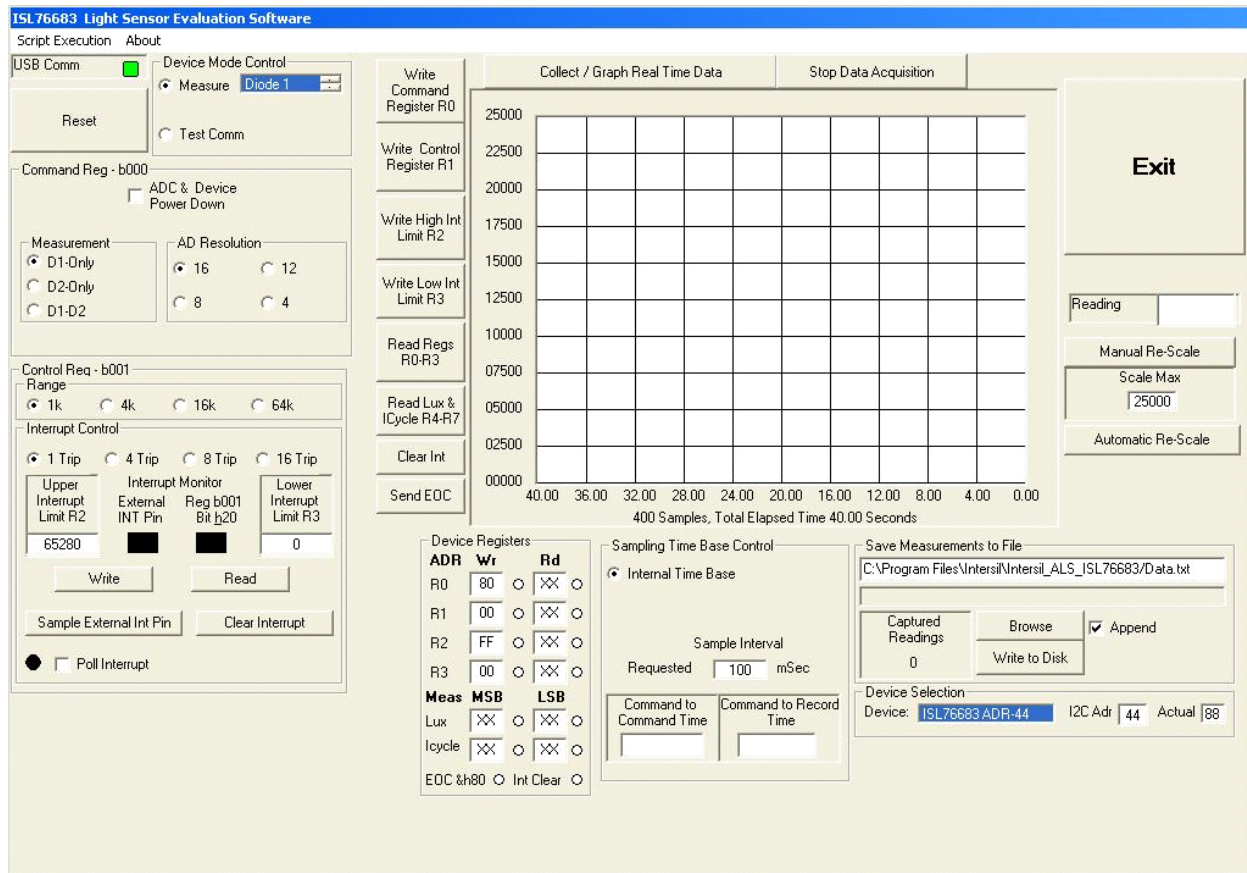

FIGURE 4. ISL76683 LIGHT SENSOR EVALUATION SOFTWARE USER INTERFACE

Using the ISL76683 Light Sensor Evaluation Software

USB Communications

In the upper left corner of the **ISL76683 Light Sensor Evaluation Software** window, in the **USB Comm** area, ensure that the light is green (Figure 5). If it is not green, check the USB cable connection.

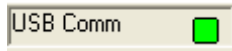

FIGURE 5. USB COMMUNICATIONS INDICATOR

Test Communications

In the upper left corner of the **ISL76683 Light Sensor Evaluation Software** window, in the **Device Mode Control** dialog area, click the **Test Comm** radio button to test communications between the PC and the evaluation board. If it shows **Good**, as shown in Figure 6, then the hardware and software are properly set up. If it shows **Fail**, check the connections between the PC and the board. If the problem persists, restart the software.

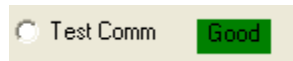

FIGURE 6. TEST COMMUNICATIONS

Device Registers

The **Device Registers** area (Figure 7) in the bottom center of the **ISL76683 Light Sensor Evaluation Software** window displays the current state of the device registers (Figure 7A). Use the column of buttons to the left of the **Collect/Graph Real Time Data** grid (top center) (Figure 7B) to read or write to the registers.

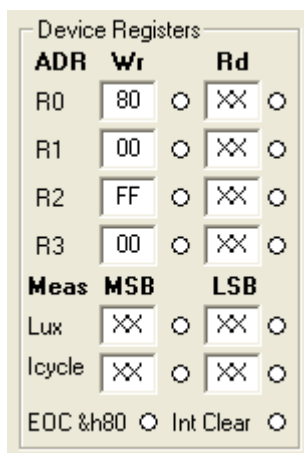

FIGURE 7A.

FIGURE 7. DEVICE REGISTERS STATUS, READ, AND WRITE

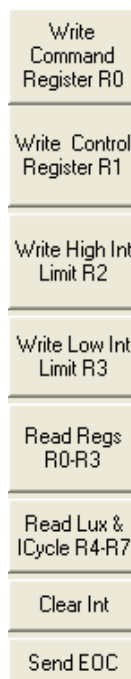

FIGURE 7B.

Command Register 00 (Hex)

ADC RESET AND DEVICE POWER-DOWN

In the upper left corner of the **ISL76683 Light Sensor Evaluation Software** window, in the **Command Reg - b000** dialog area, click the **ADC & Device Power Down** check box to disable and reset the ADC and to put the ISL76683 into power-down mode.



FIGURE 8. ADC RESET AND DEVICE POWER-DOWN

MEASUREMENT MODE SELECTION

The ISL76683 contains two photodiodes. Diode 1 is sensitive to both visible and infrared light, while Diode 2 is sensitive mostly to infrared light. Measurement Mode 1 is Diode 1 only, and Measurement Mode 2 is Diode 2 only. Measurement Mode 3 is a sequential Mode 1 and Mode 2, with an internal subtract function (Diode 1 - Diode 2).

You can select the measurement mode in one of two ways. In the upper left corner of the **ISL76683 Light Sensor Evaluation Software** window, in the **Device Mode Control** dialog area, click the **Measure** radio button, and from the scroll list, select the diode to be measured (Figure 9A). Or, in the **Command Reg - b000** dialog area, under **Measurement**, click one of three radio buttons to select the diode to measure (Figure 9B).



FIGURE 9A.

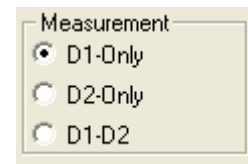

FIGURE 9B.

FIGURE 9. MEASUREMENT MODE SELECTION

AD RESOLUTION

Changing the number of clock cycles does more than just change the resolution of the device; it also changes the integration time, which is the period the device's analog-to-digital converter (ADC) samples the photodiode current signal for a lux measurement. To change the device resolution (and integration time), in the **Command Reg - b000** dialog area, under **AD Resolution**, click one of the four radio buttons to select the number of clock cycles per conversion.

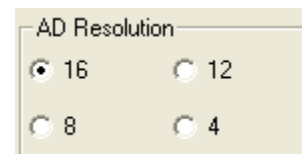

FIGURE 10. AD RESOLUTION SELECTION

Control Register 01 (Hex)

RANGE/GAIN SELECTION

The ADC has four I²C programmable range (gain) selections to dynamically accommodate various lighting conditions. For example, a very bright object requires a higher range (e.g., 64k) than a dark object, which requires a low range (e.g., 1k). Higher ranges reduce photo detector sensitivity. In the **ISL76683 Light Sensor Evaluation Software** window, in the **Control Reg - b001** dialog area, under **Range**, click one of the four radio buttons to select the range to match lighting conditions.

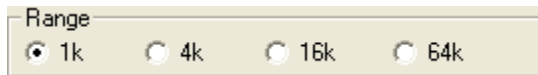

FIGURE 11. RANGE/GAIN SELECT

Interrupt Control Register 01 (Hex) and Threshold Registers 02 (Hex) and 03 (Hex)

Interrupt thresholds are stored in Registers 0x02 and 0x03. In the **Interrupt Control** dialog (Figure 12), enter values in the **Upper Interrupt Limit R2** and **Lower Interrupt Limit R3** text boxes and click **Write** to edit the interrupt thresholds. (See the [ISL76683 datasheet](#) for more information on interrupt limits.) The interrupt thresholds act as an alarm or monitoring function to determine whether the ADC count exceeds the upper or lower limit.

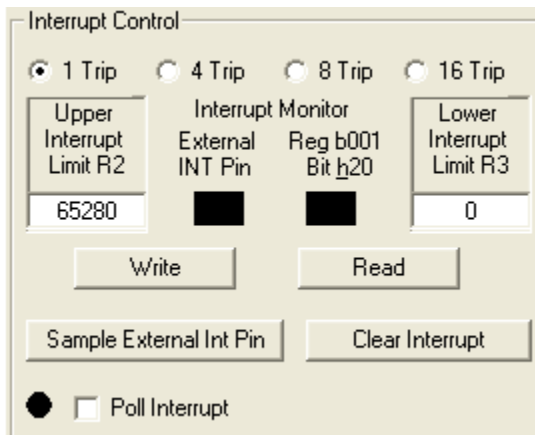

FIGURE 12. INTERRUPT CONTROL

To set the interrupt limits in the **Interrupt Control** dialog (see Table 2 for parameter descriptions):

1. Click one of the four radio buttons across the top of the dialog window to choose an interrupt persistence value (recommended value: 8 Trip).
2. Enter decimal values in the **Upper Interrupt Limit R2** and **Lower Interrupt Limit R3** text boxes. The upper limit must be greater than the lower limit. Values for the limits depend on the application, the configuration of other options, and the distance at which you choose to flag.
3. Click **Write** and then click **Read**. Verify the desired limit values by comparing the values entered for the intended limits to the values in the **Device Registers** dialog after clicking **Read**. If they do not match, repeat Steps 2 and 3.

4. Click **Clear Interrupt** to clear or reset the interrupt status bit.
5. You can manually poll the Interrupt pin (Pin 4 on the ISL76683EVAL1Z evaluation board) or you can set it to be polled automatically. To poll it manually, click **Sample External Int Pin**. To poll it automatically, click the **Poll Interrupt** check box to select it.

With interrupt limits set, you can begin collecting data. Data is collected within the upper and lower limits you selected. In the **Interrupt Control** dialog, in the **Interrupt Monitor** area, black boxes indicate an unflagged status that is within limits. Red boxes indicate the data collected is either above the upper limit or below the lower limit and that the interrupt flag has been triggered.

TABLE 2. INTERRUPT CONTROL PARAMETERS

| PARAMETER | DESCRIPTION |
|--------------------------|--|
| Interrupt Persistence | Sets the number of times the upper limit is exceeded or lower limit is subceeded before an alarm or interrupt flag is raised. |
| Upper Interrupt Limit R2 | Applies to Interrupt Threshold HI Register 0x02. This register sets the HI threshold for the Interrupt pin and the interrupt flag. By default, the interrupt threshold HI is FF (hex). The 8-bit data written to the register represents the upper MSB of a 16-bit value. The LSB is always 00 (hex). |
| Lower Interrupt Limit R3 | Applies to Interrupt Threshold LO Register 0x03. This register sets the LO threshold for the Interrupt pin and the interrupt flag. By default, the Interrupt threshold LO is 00 (hex). The 8-bit data written to the register represents the upper MSB of a 16-bit value. The LSB is always 00 (hex). |
| Write, Read | Store or read values in the upper and lower interrupt limit threshold Registers 0x02 and 0x03. |
| Clear Interrupt | Click Clear Interrupt to clear or reset the interrupt status bit. |
| Sample External Int Pin | Manually sample the external interrupt pin (Pin 4) on the IC. |
| Poll Interrupt | Allows checking of the external interrupt status while sampling data. |
| Interrupt Monitor | <ul style="list-style-type: none"> • Square indicator light displays status: black means no fault; red means an interrupt fault. • Monitor external interrupt pin manually by clicking Sample External Int Pin button or automatically by clicking Poll Interrupt check box to select it. Reg b001, Bit h20, can only be monitored manually. |

Application Note 1657

Data Collection

In the **ISL76683 Light Sensor Evaluation Software** window, use the **Collect/Graph Real Time Data** dialog (Figure 13) to acquire and graph measurements.

- Click **Collect/Graph Real Time Data** to sample data. Samples are taken and plotted, and values are displayed in the **Reading** field on the right side of the dialog. The **Reading** field displays the value of the ADC output coming out of the sensor in accordance with the mode that is engaged.
- Click **Stop Data Acquisition** to stop data sampling.
- Click **Exit** to close the entire program.
- In the **Scale Max** text box, enter a maximum value for the scale (vertical axis), and click **Manual Re-Scale** to re-set.
- Click **Automatic Re-Scale** to re-scale the vertical axis to an appropriate field of view. This feature is useful if the sampled data is out of the range of the graph or if you need to zoom in on the data.

Saving Measurements to File

Use the **Save Measurements to File** dialog box in the lower right corner of the **ISL76683 Light Sensor Evaluation Software** window to save a series of measurements to disk. Click **Browse** to enter a filename and select a file path. Click **Write to Disk** to write the current graph data to disk.

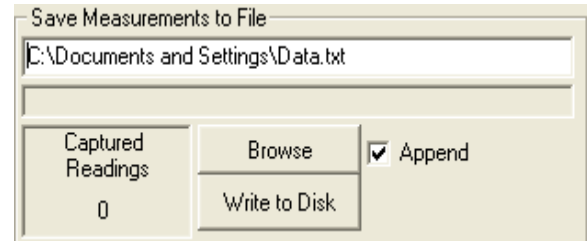

FIGURE 14. SAVE MEASUREMENTS TO FILE

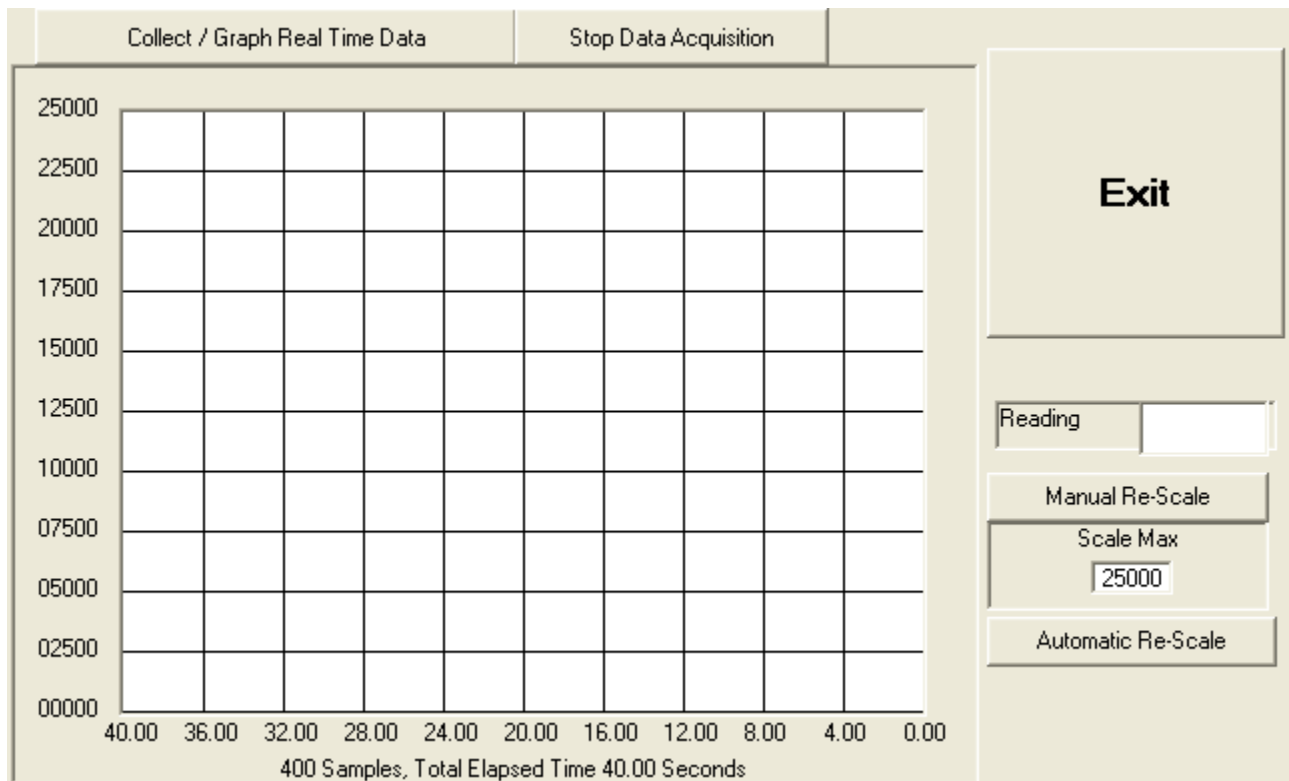

FIGURE 13. GRAPHICAL REAL-TIME DATA COLLECTION

Intersil Corporation reserves the right to make changes in circuit design, software and/or specifications at any time without notice. Accordingly, the reader is cautioned to verify that the Application Note or Technical Brief is current before proceeding.

For information regarding Intersil Corporation and its products, see www.intersil.com