

DETAILS

Product Number	FN14074_STELLA-HB
Family	STELLA
Type	Pack
Color	black
Diameter	90 mm
Height	19,5 mm
Style	round
Optic Material	Silicone
Holder Material	
Fastening	screw
Status	production ready
ROHS Compliant	Yes
Date Updated	21/09/2016



OPTICAL PROPERTIES

LED	Viewing	Light	Effi-		Connector
	Angle	Beam	ciency	cd/lm	
VERO18	75 deg	HighBay	93 %	0.700	-
VERO29	69 deg	HighBay	94 %	0.708	-
V22 Gen7	sim: 68	HighBay	sim: 94 %	sim: 0.853	Bender Wirth: 431 Typ L4
CLL04x/CLU04x	77 deg	HighBay	94 %	0.650	-
CLL05x/CLU05x	73 deg	HighBay	93 %	0.630	-
CLL05x/CLU05x	65 deg	HighBay	94 %	0.740	Bender Wirth: 458 Typ L4
CLL04x/CLU04x	68 deg	HighBay	93 %	0.770	Bender Wirth: 431 Typ L3
CXA/B 30xx	78 deg	HighBay	93 %	0.630	-
CXA/B 25xx	83 deg	HighBay	93 %	0.566	-
CXA/B 3590	72 deg	HighBay	93 %	0.682	-
LUXEON CoB 1211	71 deg	HighBay	93 %	0.730	-
LUXEON CoB 1216	72 deg	HighBay	94 %	0.720	-
CXM-18	80 deg	HighBay	93 %	0.600	-
CXM-22	73 deg	HighBay	93 %	0.700	-
Soleriq S19	84 deg	HighBay	92 %	0.570	-
MJT COB LES 33	68 deg	HighBay	93 %	0.700	Bender Wirth: 458 Typ L4

Relative intensity of FN14074_STELLA-HB_(CXM-22)

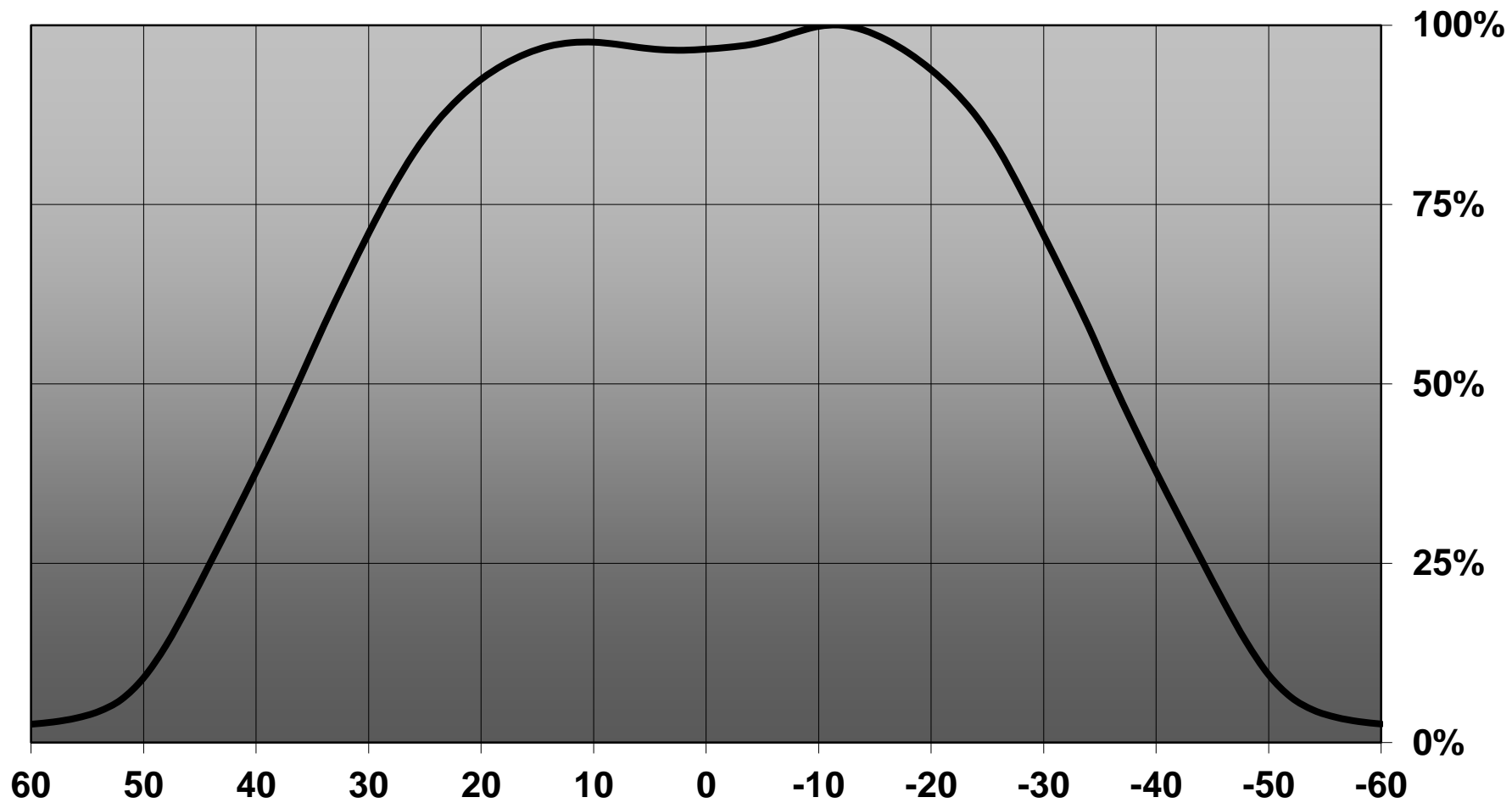

— 1: 0-180

NOTE: Maximum recommended tightening torque for STELLA-FRAME is 0,4Nm

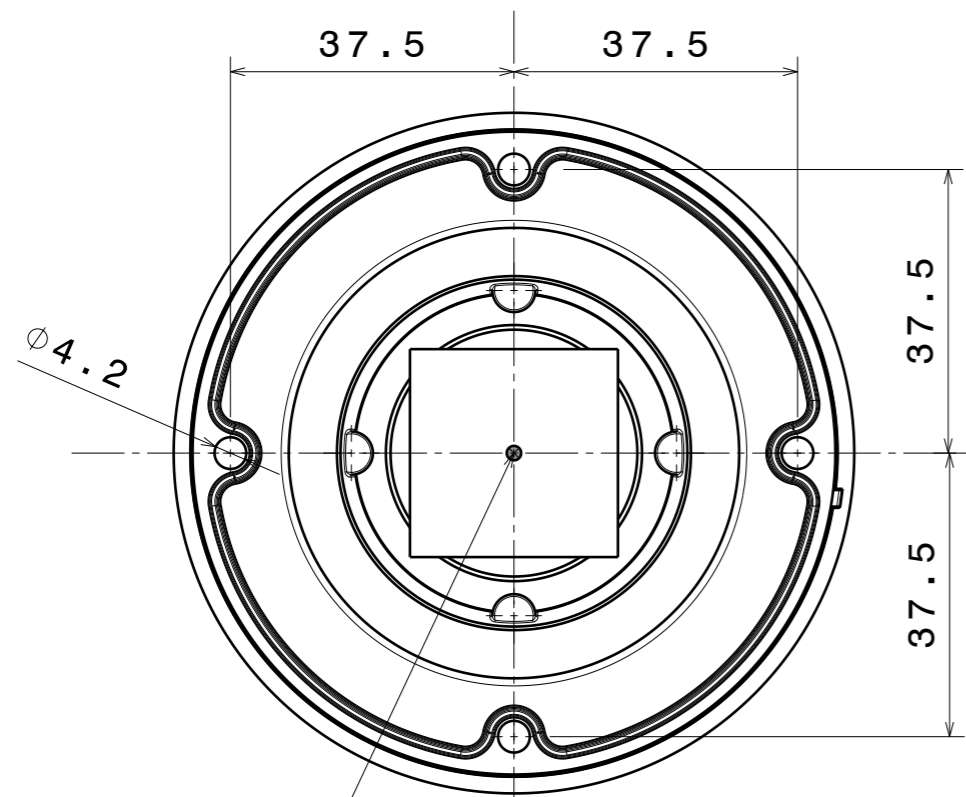

LED Center position

Bottom view

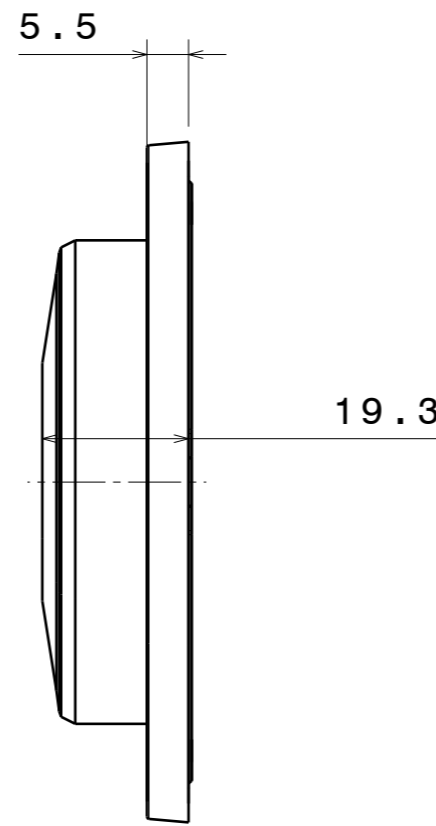

Right view

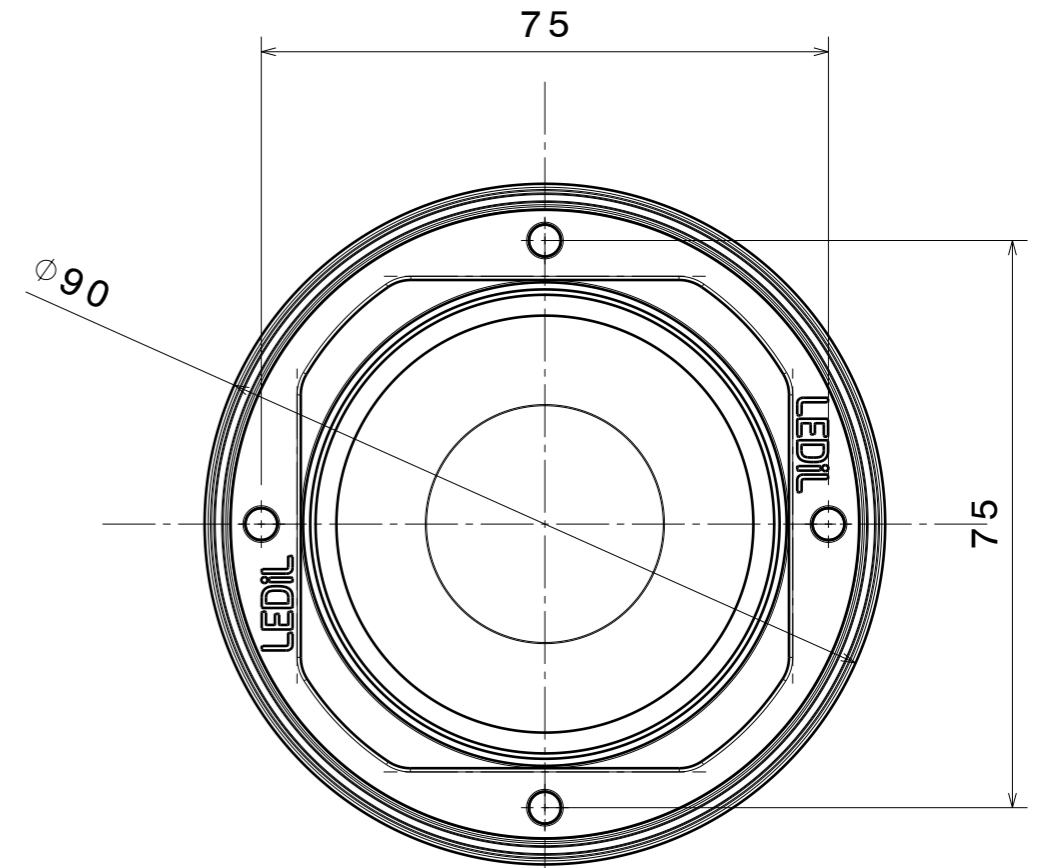

Front view

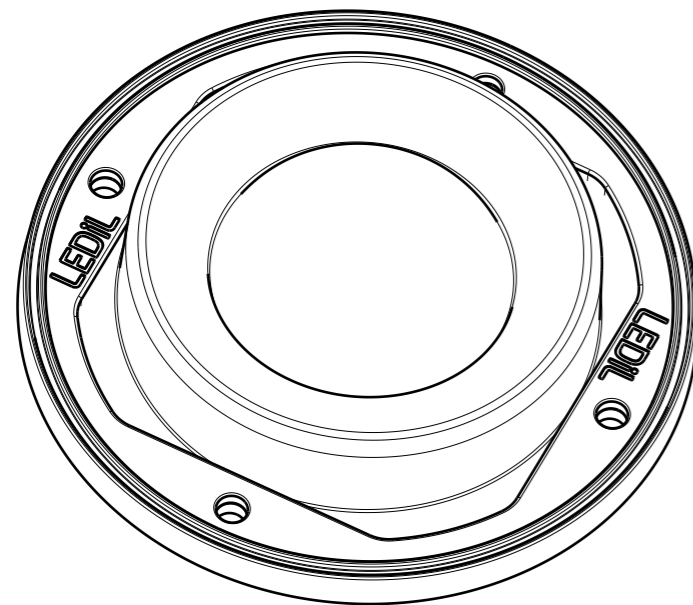

Isometric view

Lens Material: Optical grade LSR
Frame material: PA, black

Tolerances if not otherwise shown
According to DIN ISO 2768-1
Linear measures: class V
Please note that due to the elasticity of products made of silicone actual measured values may vary, and therefore typical tolerance values may not be applied.

THIRD ANGLE PROJECTION:

This drawing is the property of LEDiL Oy. It may not be reproduced, copied or communicated without a written agreement with LEDiL Oy."

Ledil Oy Salorankatu 10 FIN 24240 SALO Finland		DRAWING TITLE	
		STELLA-HB datasheet	
SIZE	PART NUMBER		
A3	FN14074		
SCALE	1:1	WEIGHT (g)	SHEET 1/1

Luminaire: LEDiL Oy FN14074_STELLA-HB_(VERO18) Eff.93%
Lamps: 1 x VERO18_(BXRC30E4000F)_904.503lm@250mA P=6.79928W I=249.9mA

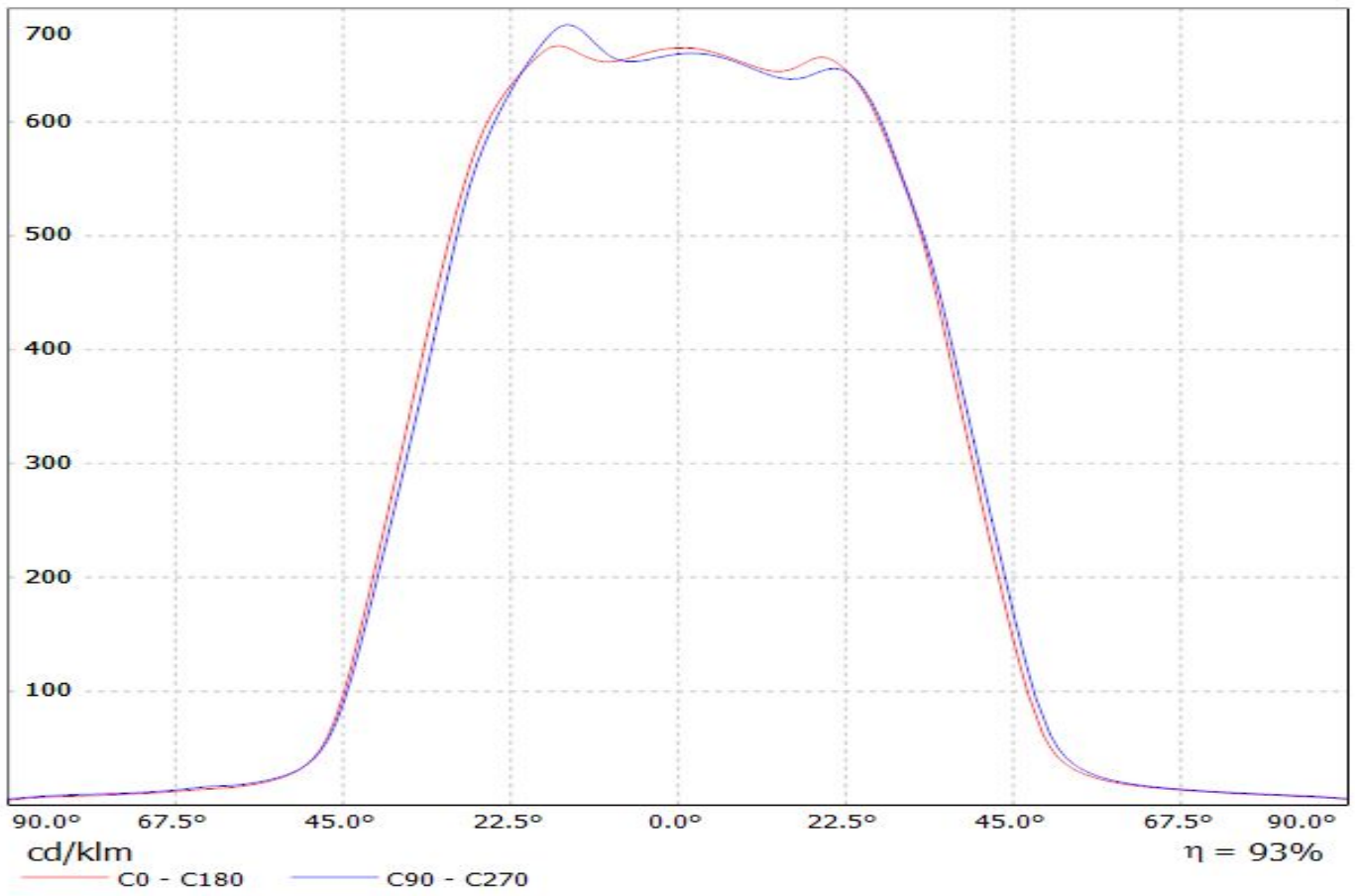

Luminaire: LEDiL Oy FN14074_STELLA-HB_(VERO29)
Lamps: 1 x Bridgelux_VERO29_(BXRC-50C10K0-L-04)
_568.615lm@100mA_CCT=4910K_P=3.4015W_I=100.1mA

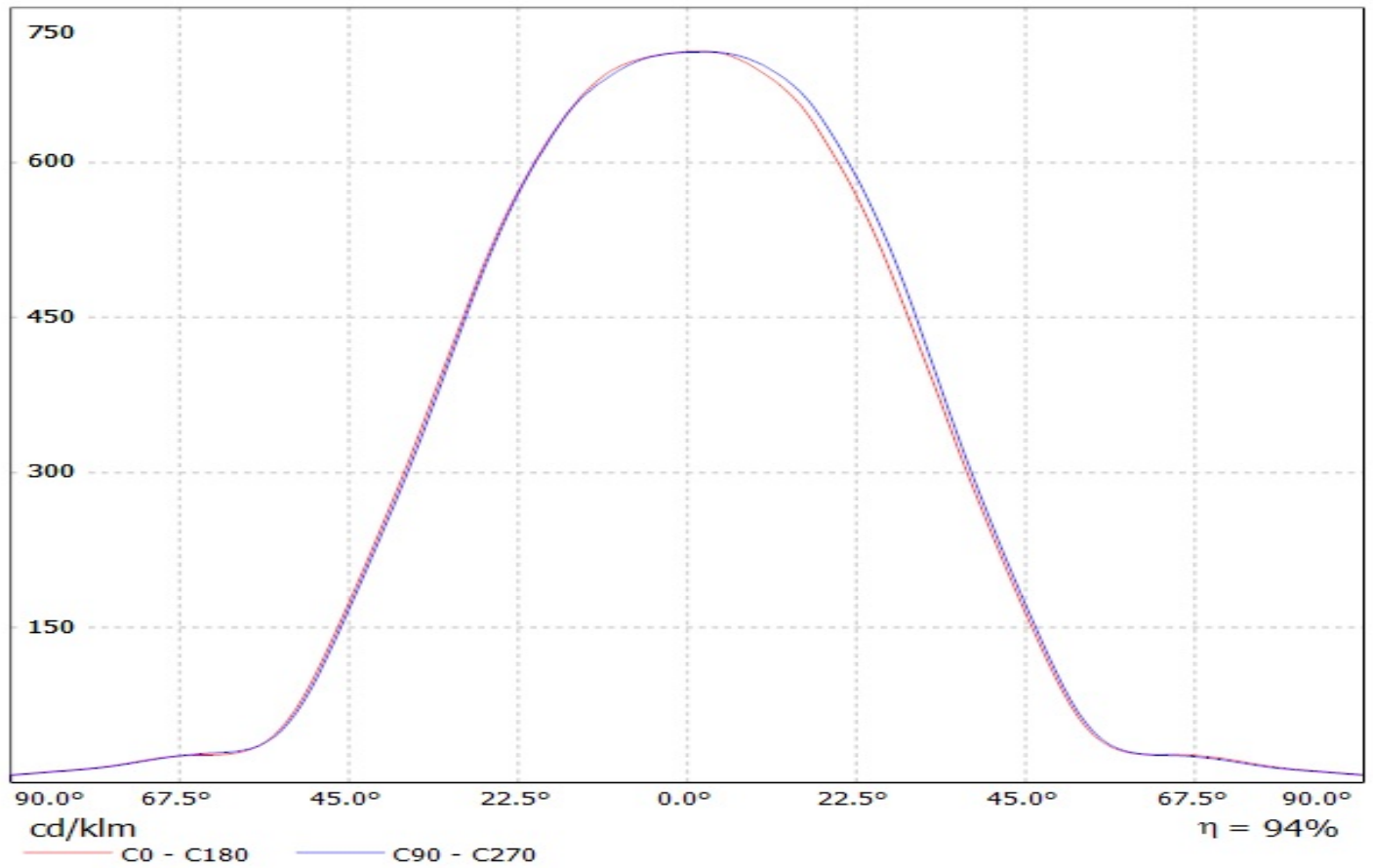

Luminaire: Ledil Oy FN14074_STELLA-HB_Bridgelux_V22_Gen7_SIMULATED FN14074_STELLA-HB_Bridgelux_V22_Gen7_SIMULATED
Lamps: 1 x FN14074_STELLA-HB_Bridgelux_V22_Gen7_SIMULATED

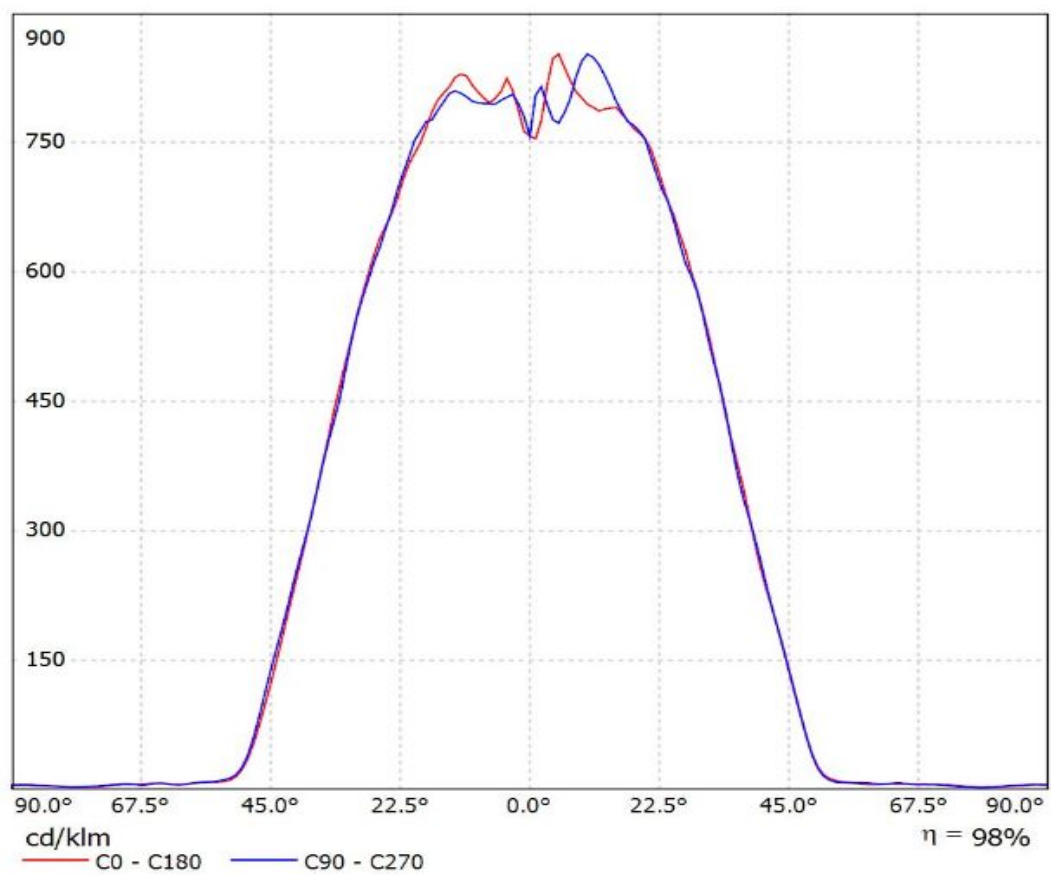

Luminaire: LEDiL Oy FN14074_STELLA-HB_(CLU046)

Lamps: 1 x Citizen_CLU046_1354.66lm@250mA_P=8.06877W_I=0.2499A

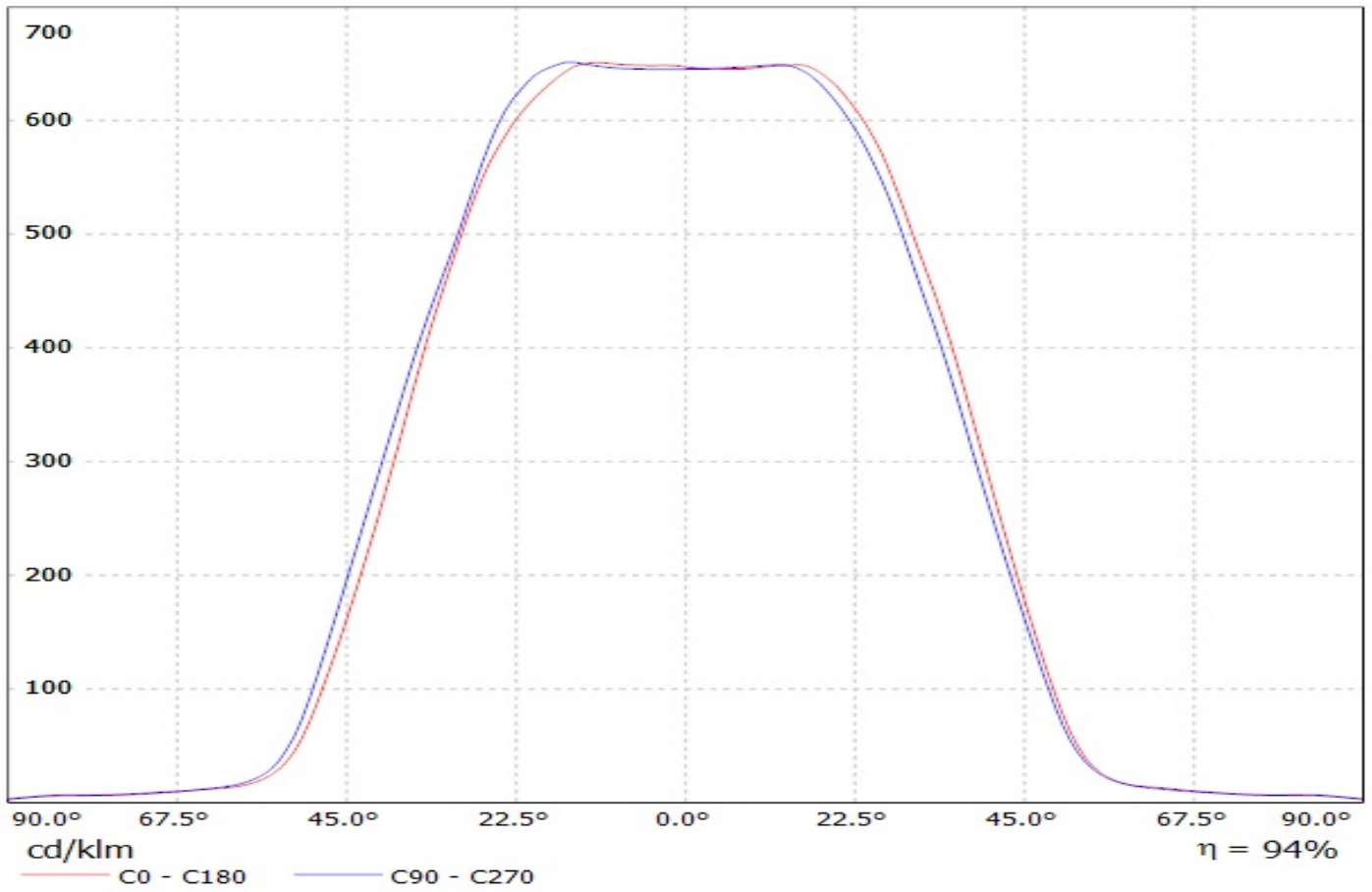

Luminaire: LEDiL Oy FN14074_STELLA-HB_(CLL050) Eff.92.5%

Lamps: 1 x CITIZEN_CLL050_(1825A1-50KL1A1)_1941.5lm@250mA_CCT=5000K_P=11.9872W_I=249.8mA

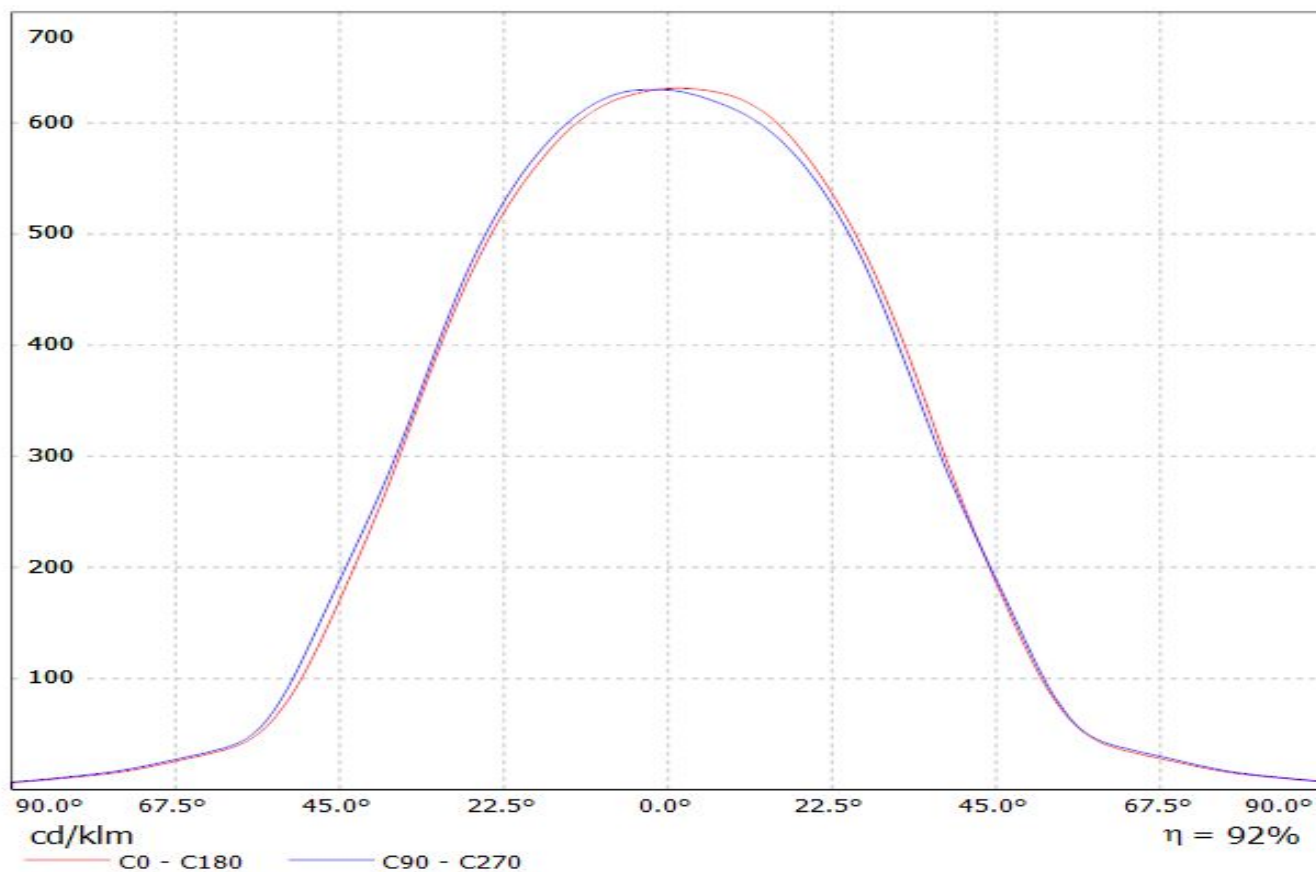

Luminaire: LEDiL Oy FN14074_STELLA-HB_(CLL050)

Lamps: 1 x CLL050+_B+W_458_Typ_L4_1471.17lm@250mA_P=12.0411W_I=250mA

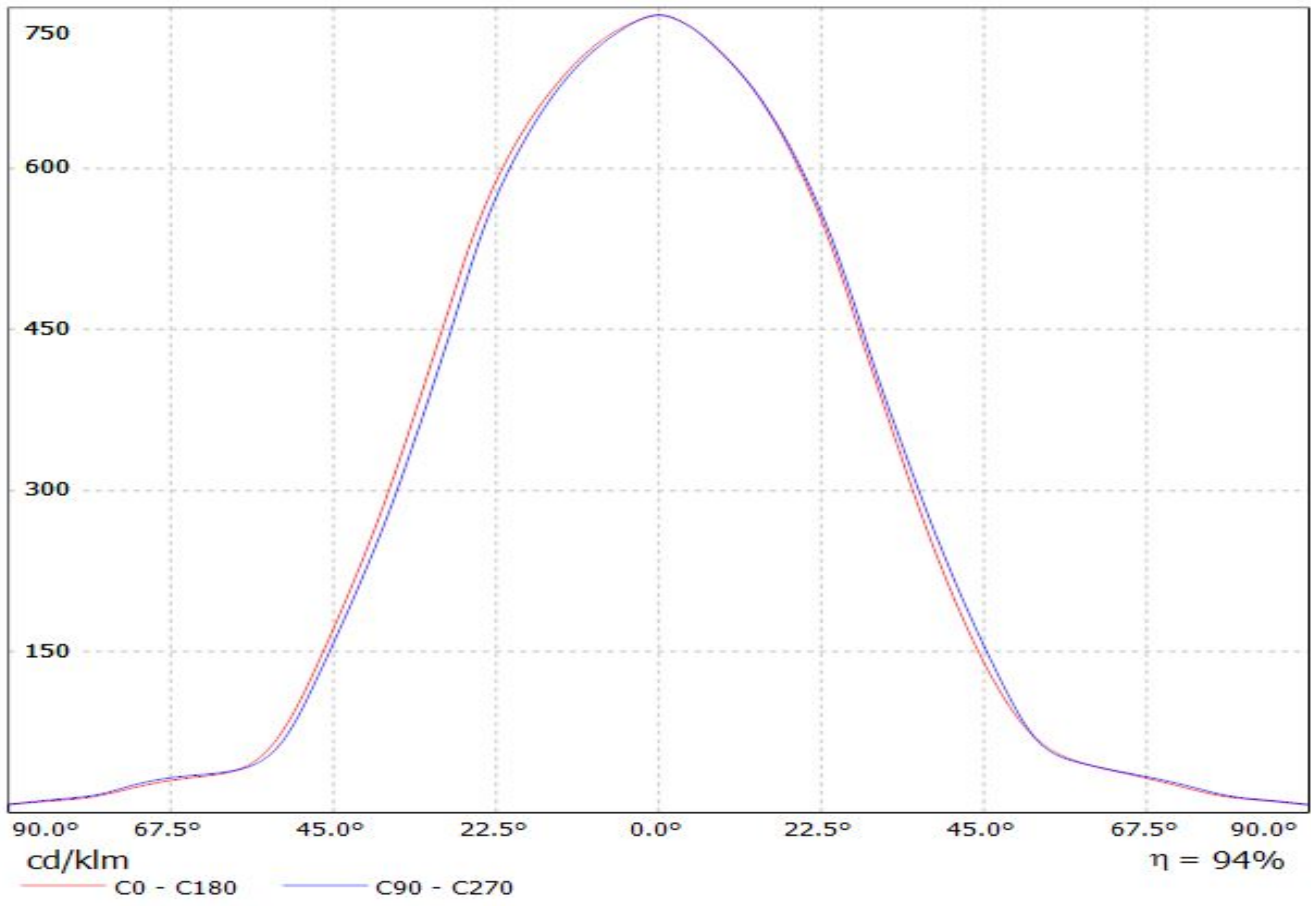

Ledil FN14074_STELLA-HB_(CLU044)_(431_Typ_L3) / LDC (Linear)

Luminaire: Ledil FN14074_STELLA-HB_(CLU044)_(431_Typ_L3)

Lamps: 1 x Citizen_CLU044_(CLU044-1212B8-303M1A2)_1334.99lm@250mA_P=8.16W_I=0.25A

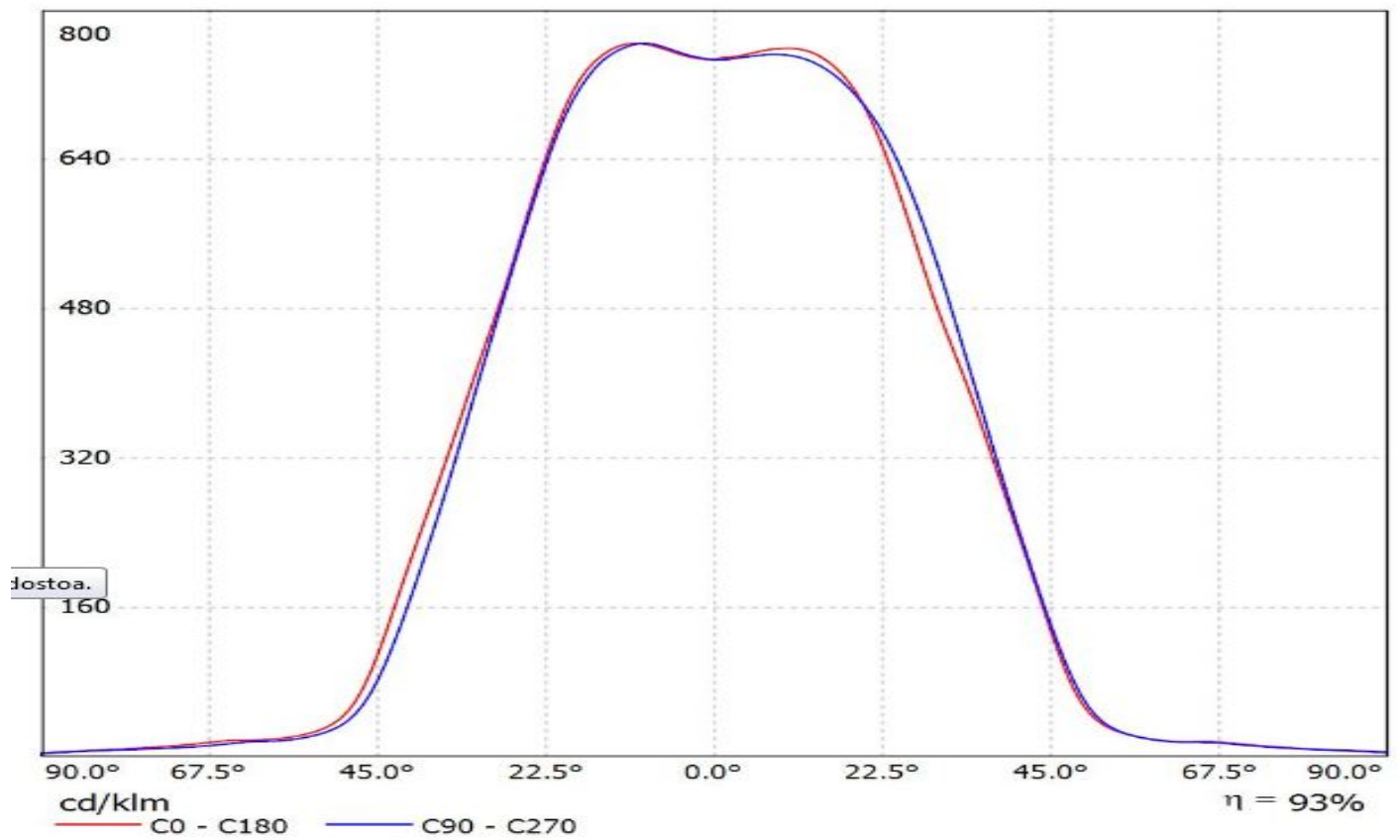

Luminaire: LEDiL Oy FN14074_STELLA-HB_(CXA3050)

Lamps: 1 x Cree_CXA30_(CXA3050-3C0-Y2-N0H)_1369.14lm@250mA_CCT=5000K_P=8.14498W_I=249.8mA

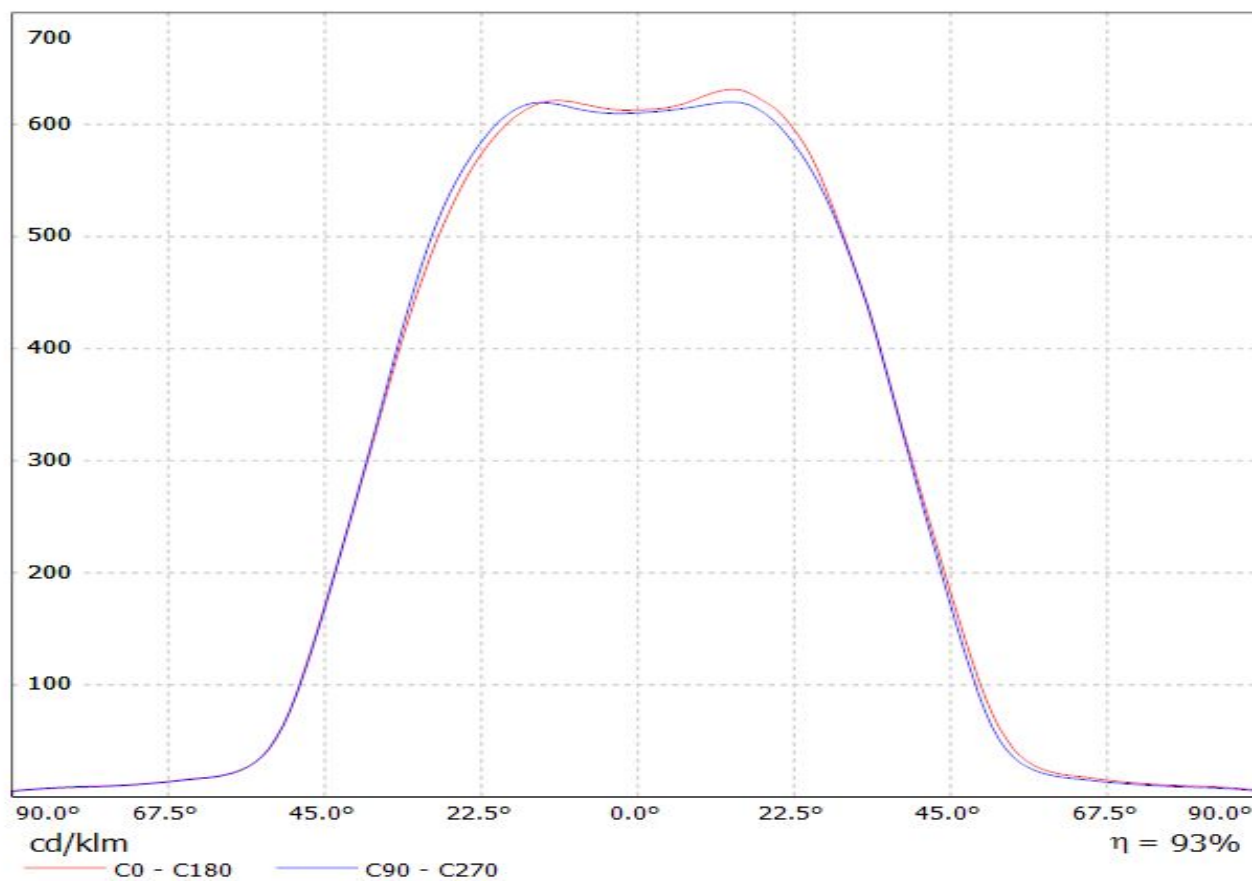

Luminaire: LEDiL Oy FN14074_STELLA-HB_(CXA25)

Lamps: 1 x CREE_CXA25_(2520-7A-N4-N0U)_872.554lm@250mA_CCT=3000K_P=8.53567W_I=249.8mA

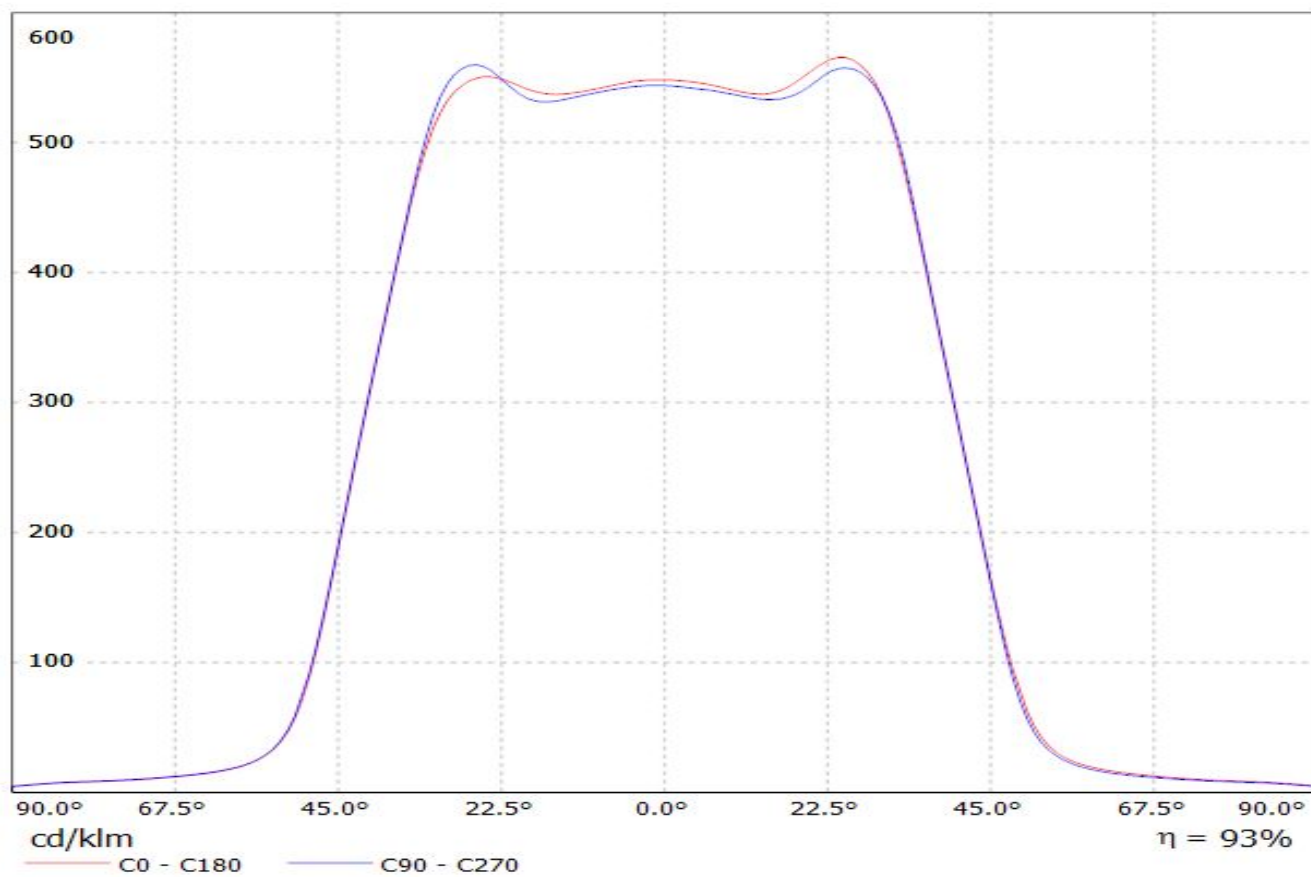

Luminaire: LEDiL Oy FN14074_STELLA-HB_(CXA3590)

Lamps: 1 x Cree_CXA3590_(CXA3590-30F-BD-R0H-0002)_2639.65lm@250mA_CCT=3000K_P=16.3039W_I=249.8mA

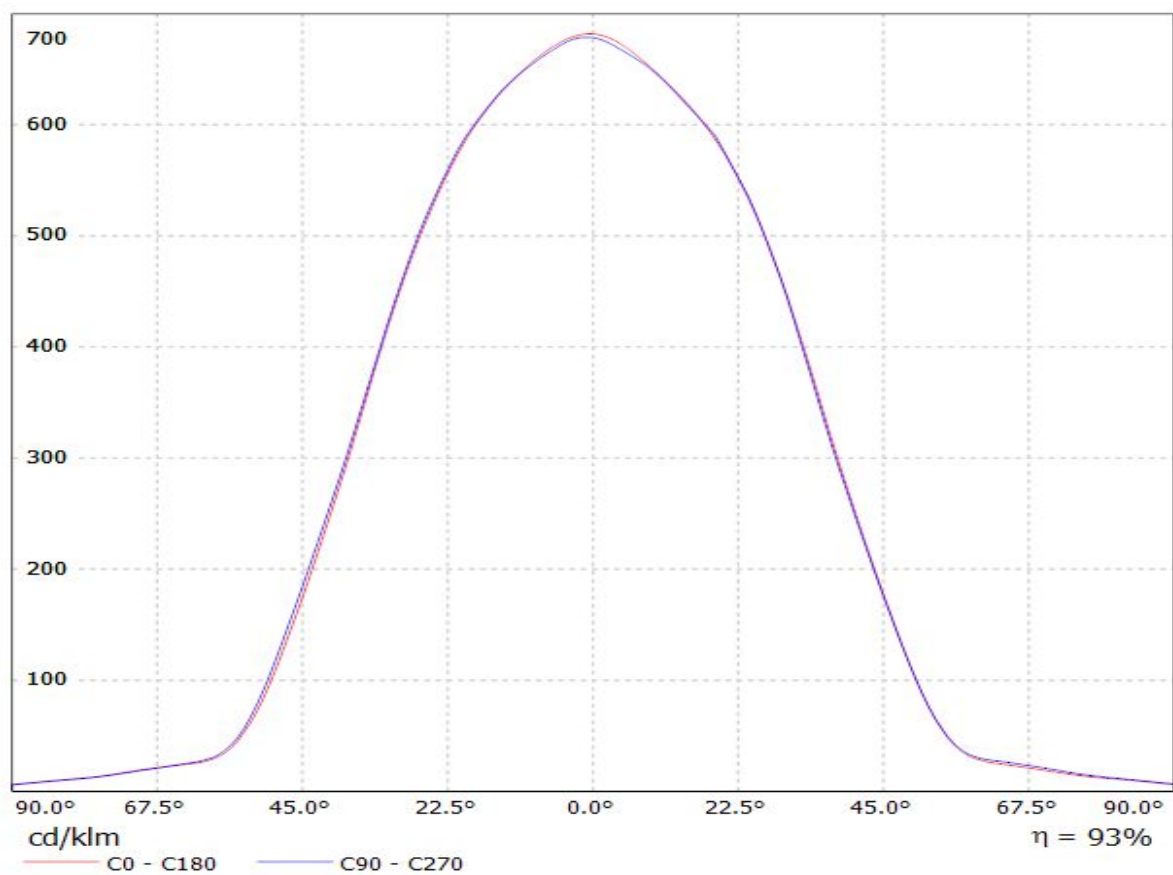

Ledil FN14074_STELLA-HB_(CoB_1211)_(431_Typ_L3) / LDC (Linear)

Luminaire: Ledil FN14074_STELLA-HB_(CoB_1211)_(431_Typ_L3)

Lamps: 1 x Luxeon_CoB_1211_(LHC1-2790-1211)_952.748lm@250mA_P=8W_I=0.25A

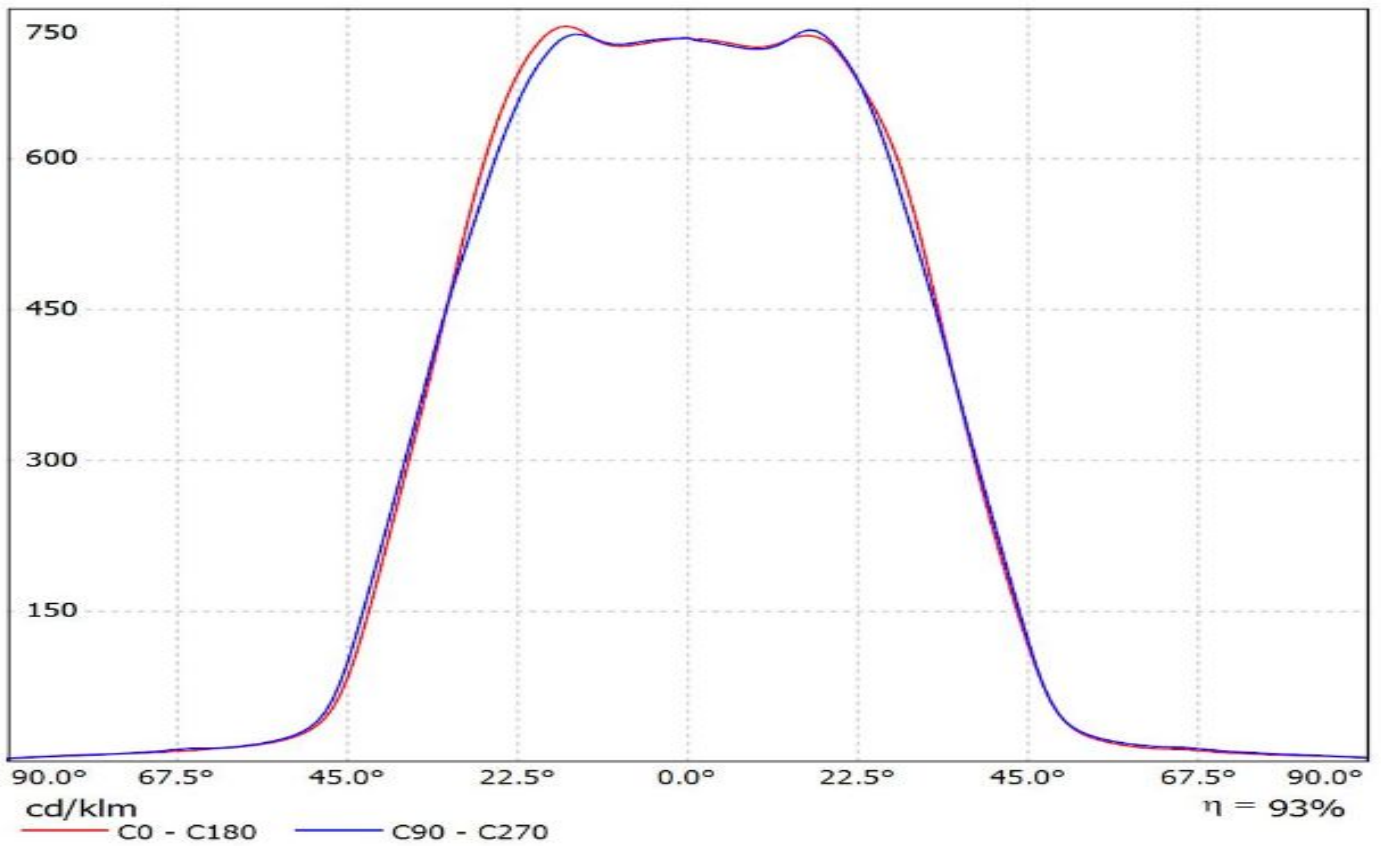

Luminaire: Ledil FN14074_STELLA-HB_(CoB_1216)

Lamps: 1 x Luxeon_CoB_1216_(L2C2-40801216E2300)_1468.12lm@250mA_P=7.9868W_I=0.25A

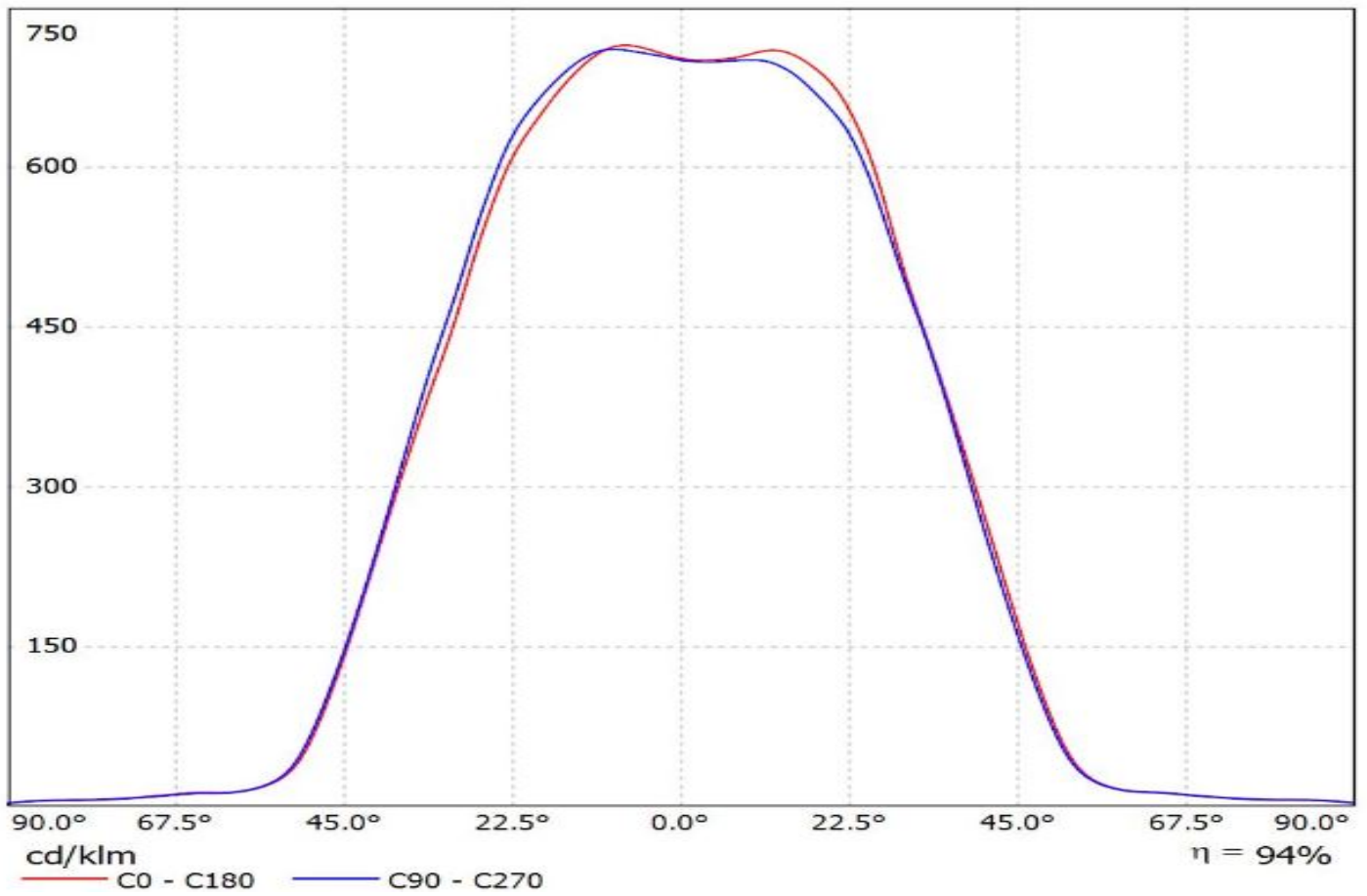

Luminaire: LEDiL Oy FN14074_STELLA-HB_(CXM-18) Eff.92.8%
Lamps: 1 x LUMINUS_XNOVA_CXM-18_897.842lm@250mA_P=8.12425W_I=249.9mA

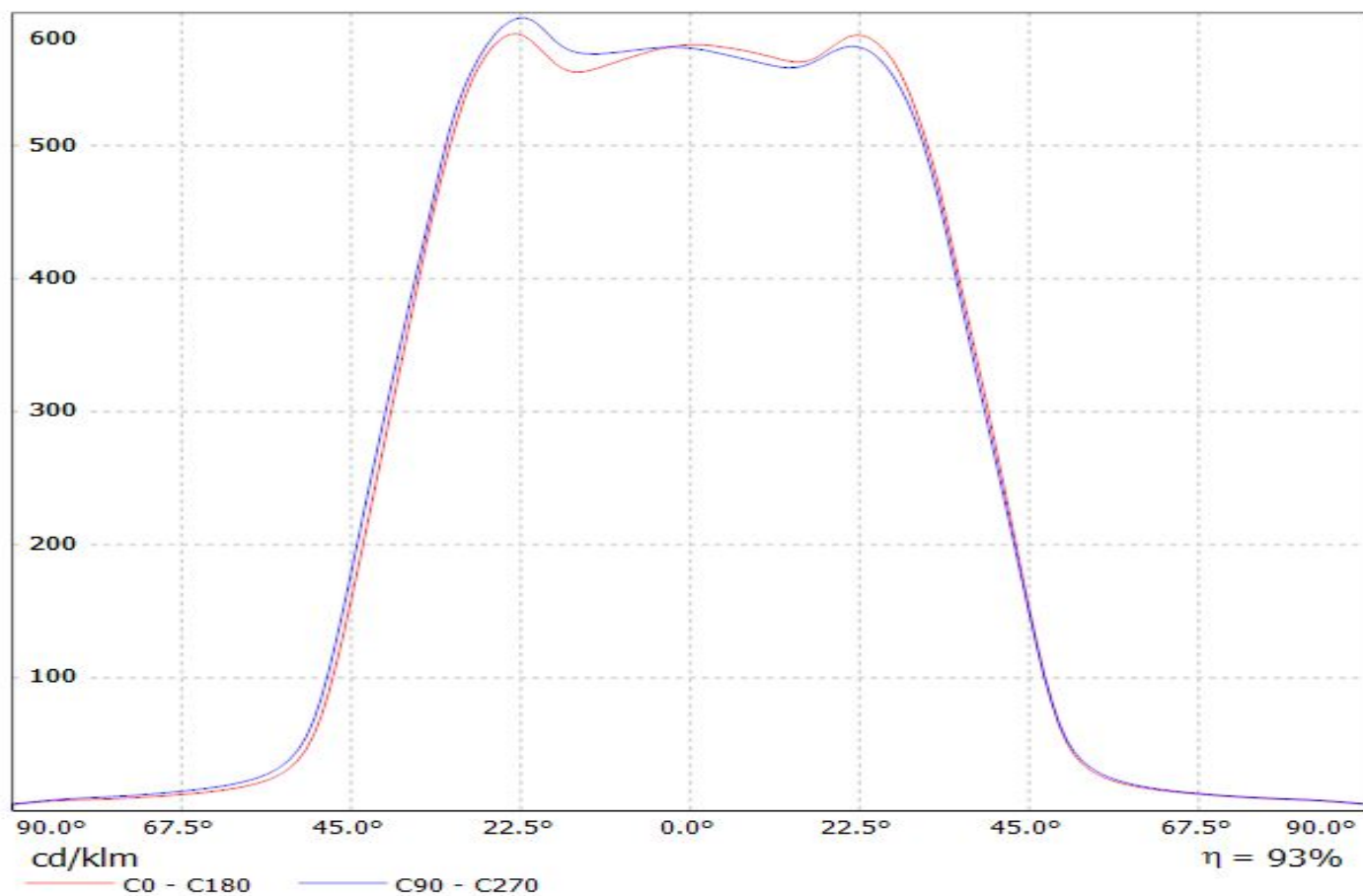

Luminaire: LEDiL Oy FN14074_STELLA-HB_(SOLERIQ_S19) Eff.92.3%
Lamps: 1 x OSRAM_SOLERIQ_S19_(GW_KAHJB1.EM)
_1401.57lm@250mA_CCT=3000K_P=10.4274W_I=249.8mA

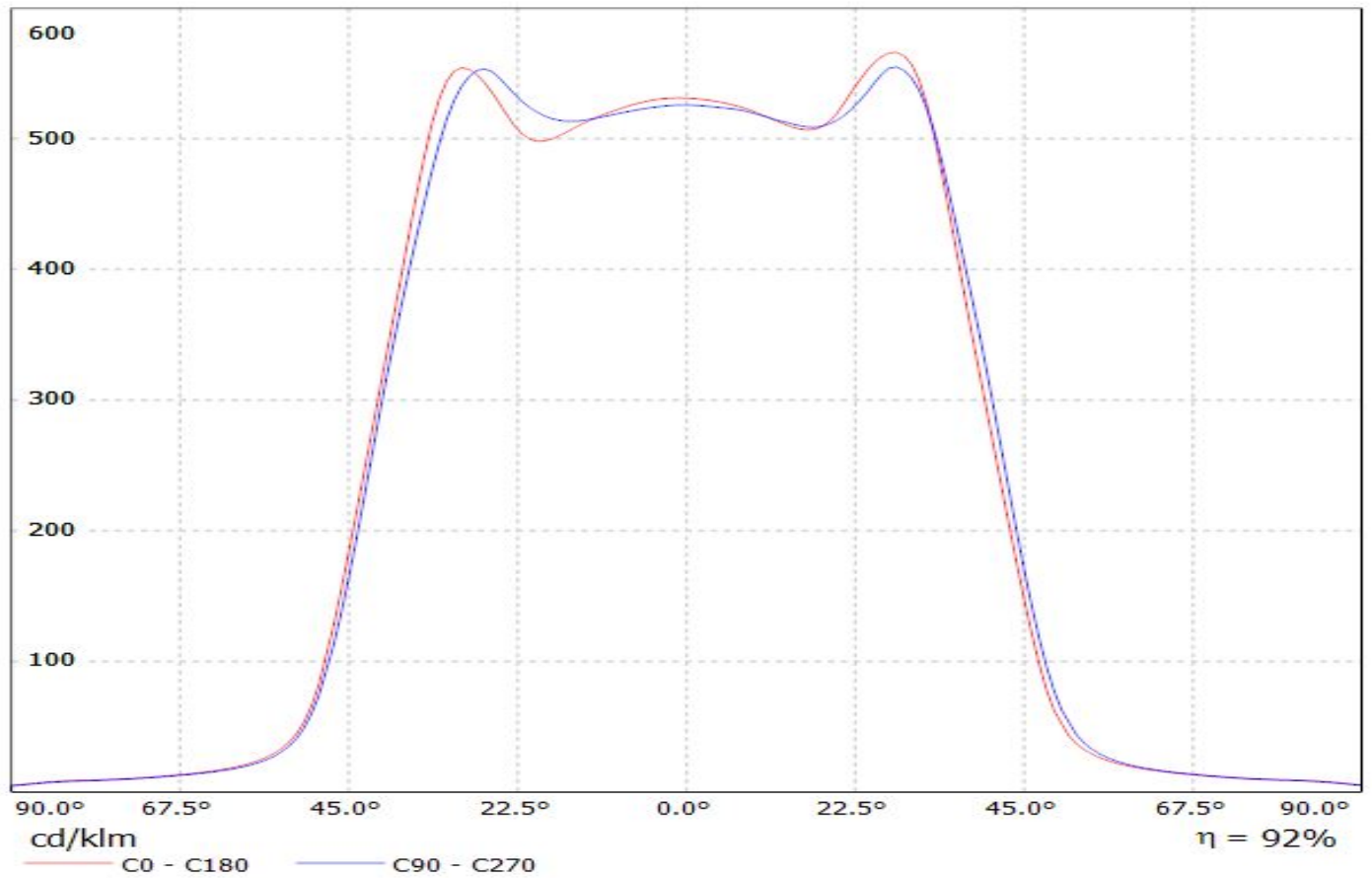

Luminaire: Ledil FN14074_STELLA-HB_(MJT_180W_Les32,8)_+458TypL4
Lamps: 1 x Seoul_MJT_180W_Les32,8mm_(SAWx33GCA)_+458TypL4_3749.72lm@250mA_P=20.9727W_I=0.25A

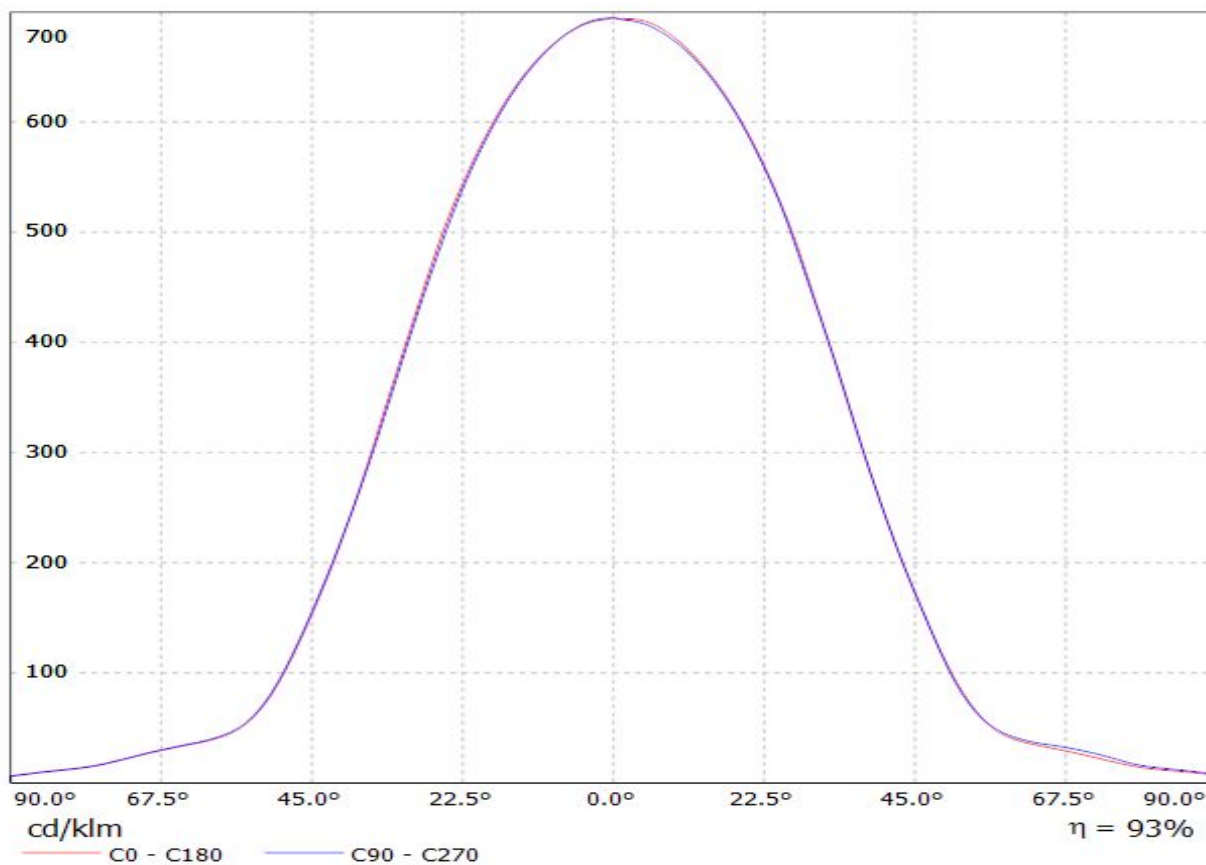

Luminaire: LEDiL Oy FN14074_STELLA-HB_(VERO18) Eff.93%

Lamps: 1 x VERO18_(BXRC30E4000F)_904.503lm@250mA P=6.79928W I=249.9mA

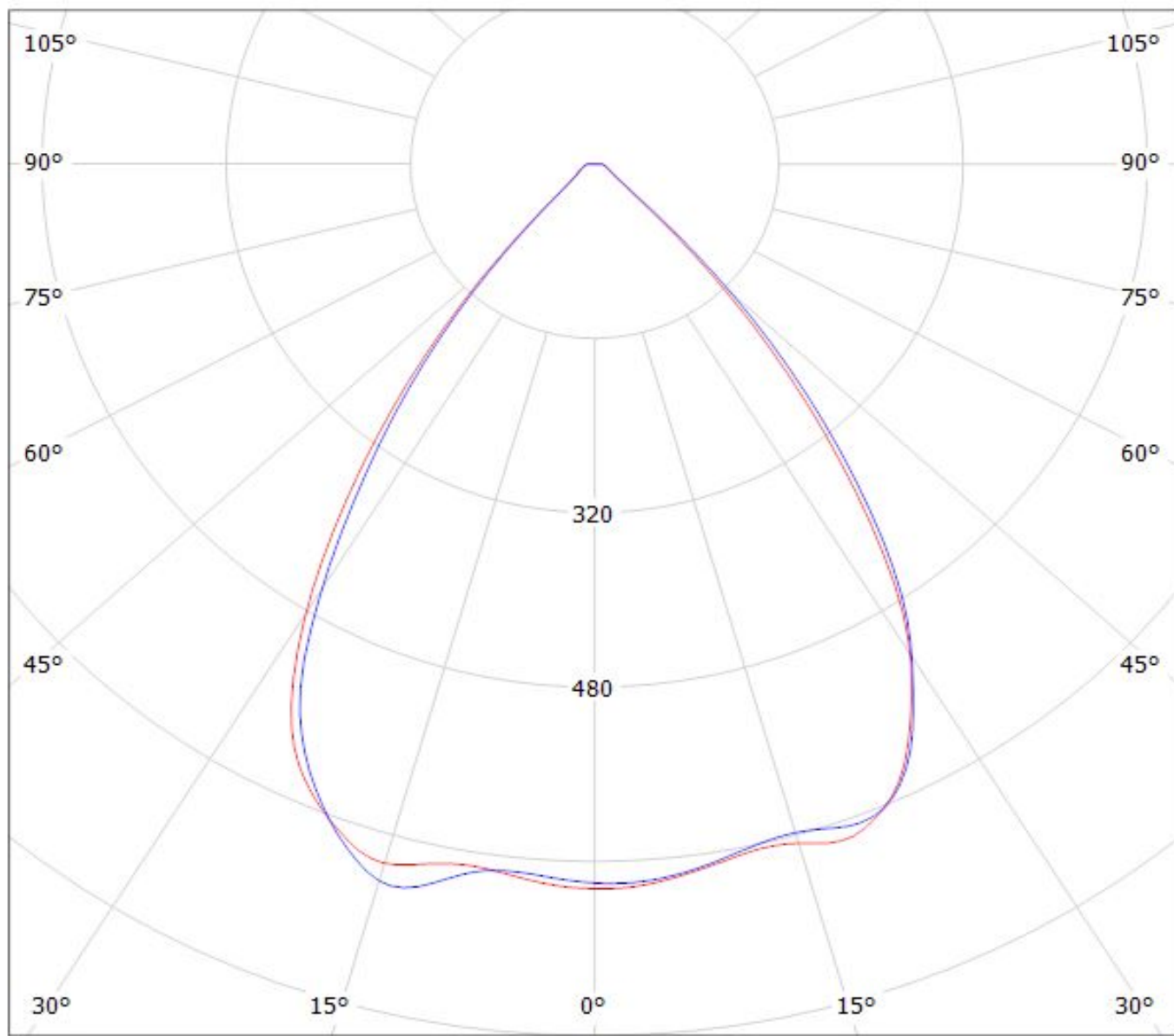

cd/klm

— C0 - C180 — C90 - C270

$\eta = 93\%$

Luminaire: LEDiL Oy FN14074_STELLA-HB_(VERO29)
Lamps: 1 x Bridgelux_VERO29_(BXRC-50C10K0-L-04)
_568.615lm@100mA_CCT=4910K_P=3.4015W_I=100.1mA

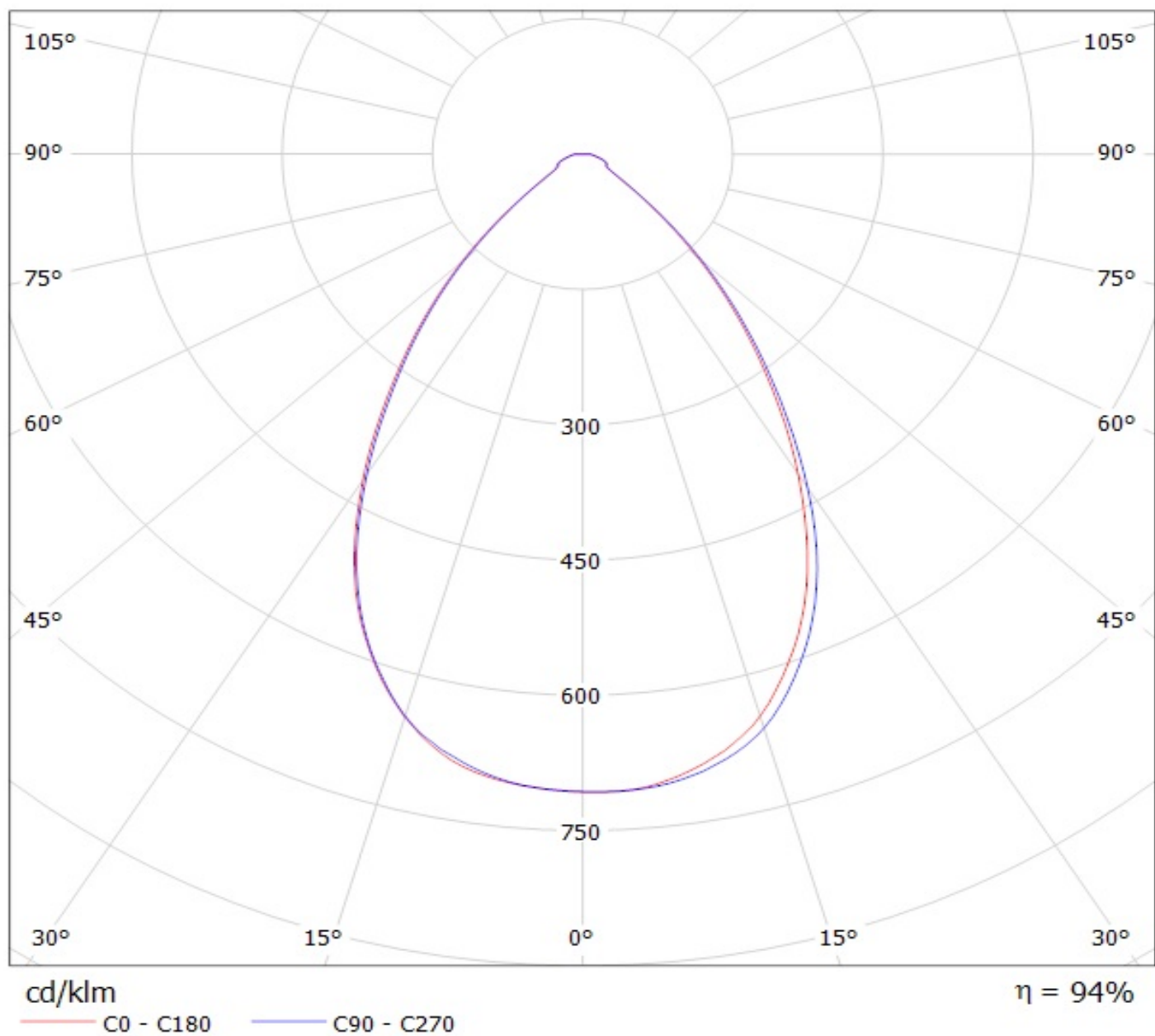

Luminaire: Ledil Oy FN14074_STELLA-HB_Bridgelux_V22_Gen7_SIMULATED FN14074_STELLA-HB_Bridgelux_V22_Gen7_SIMULATED
Lamps: 1 x FN14074_STELLA-HB_Bridgelux_V22_Gen7_SIMULATED

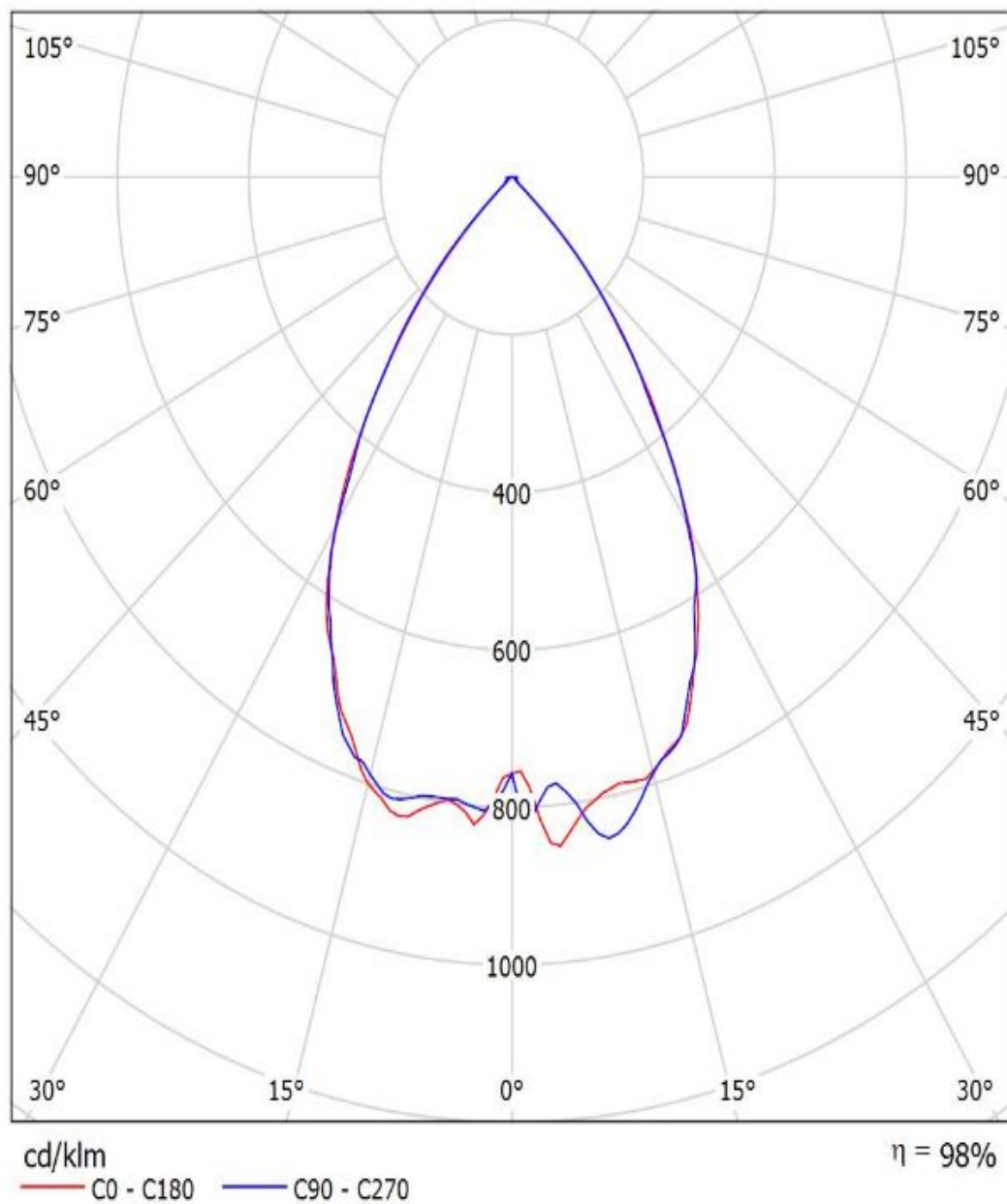

Luminaire: LEDiL Oy FN14074_STELLA-HB_(CLU046)

Lamps: 1 x Citizen_CLU046_1354.66lm@250mA_P=8.06877W_I=0.2499A

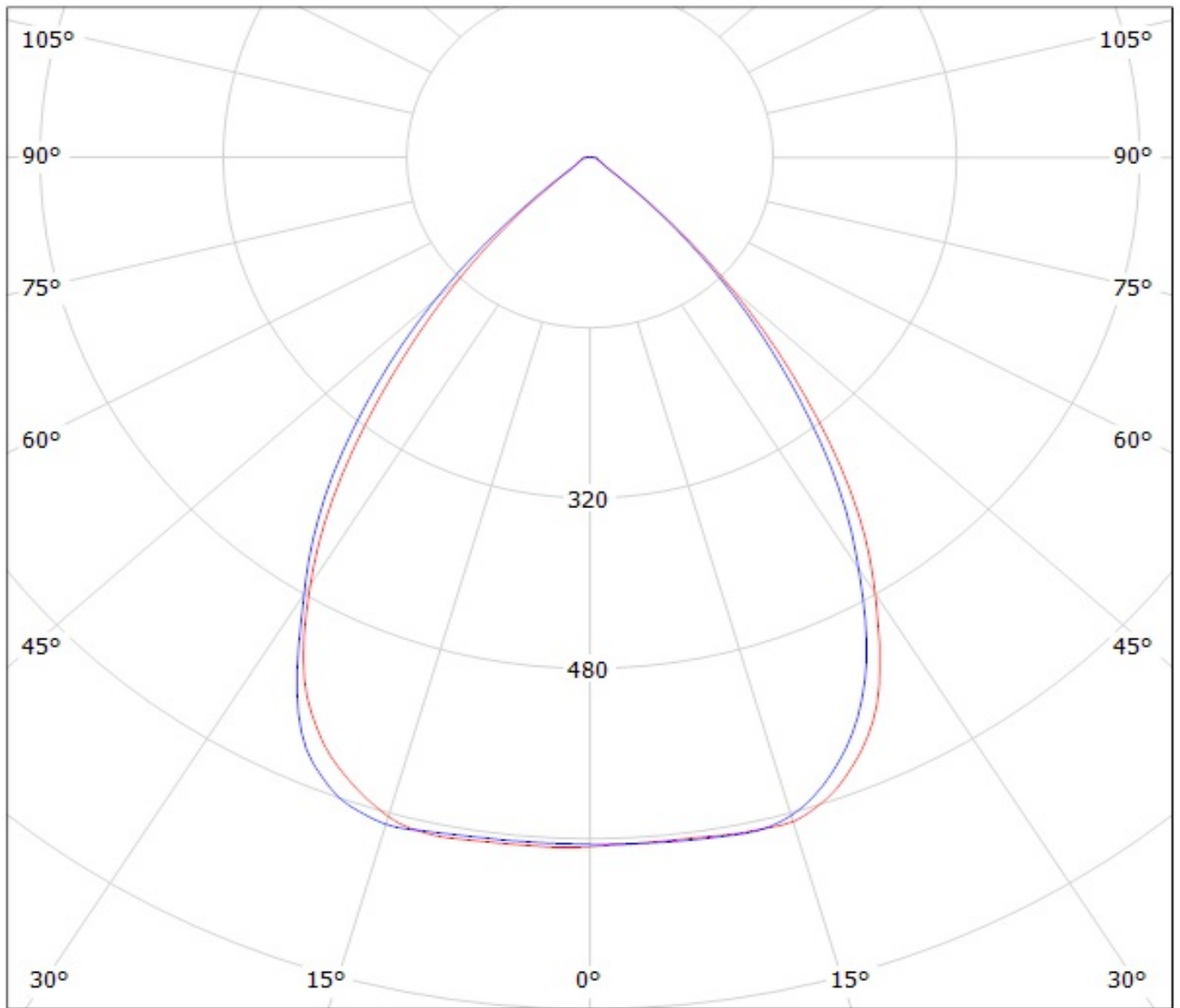

cd/klm

— C0 - C180

— C90 - C270

$\eta = 94\%$

Luminaire: LEDiL Oy FN14074_STELLA-HB_(CLL050) Eff.92.5%

Lamps: 1 x CITIZEN_CLL050_(1825A1-50KL1A1)_1941.51lm@250mA_CCT=5000K_P=11.9872W_I=249.8mA

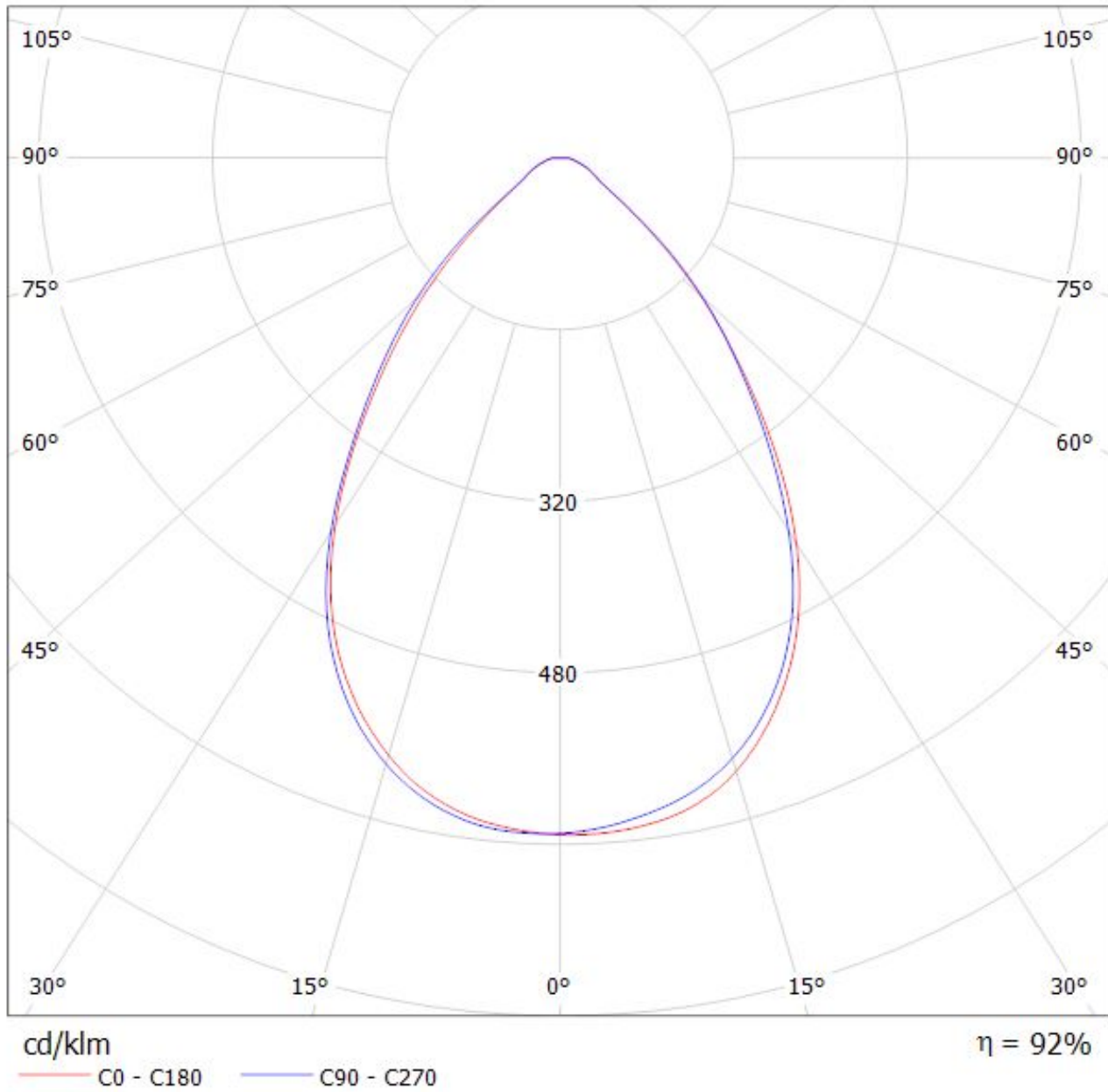

Luminaire: LEDiL Oy FN14074_STELLA-HB_(CLL050)

Lamps: 1 x CLL050+_B+W_458_Typ_L4_1471.17lm@250mA_P=12.0411W_I=250mA

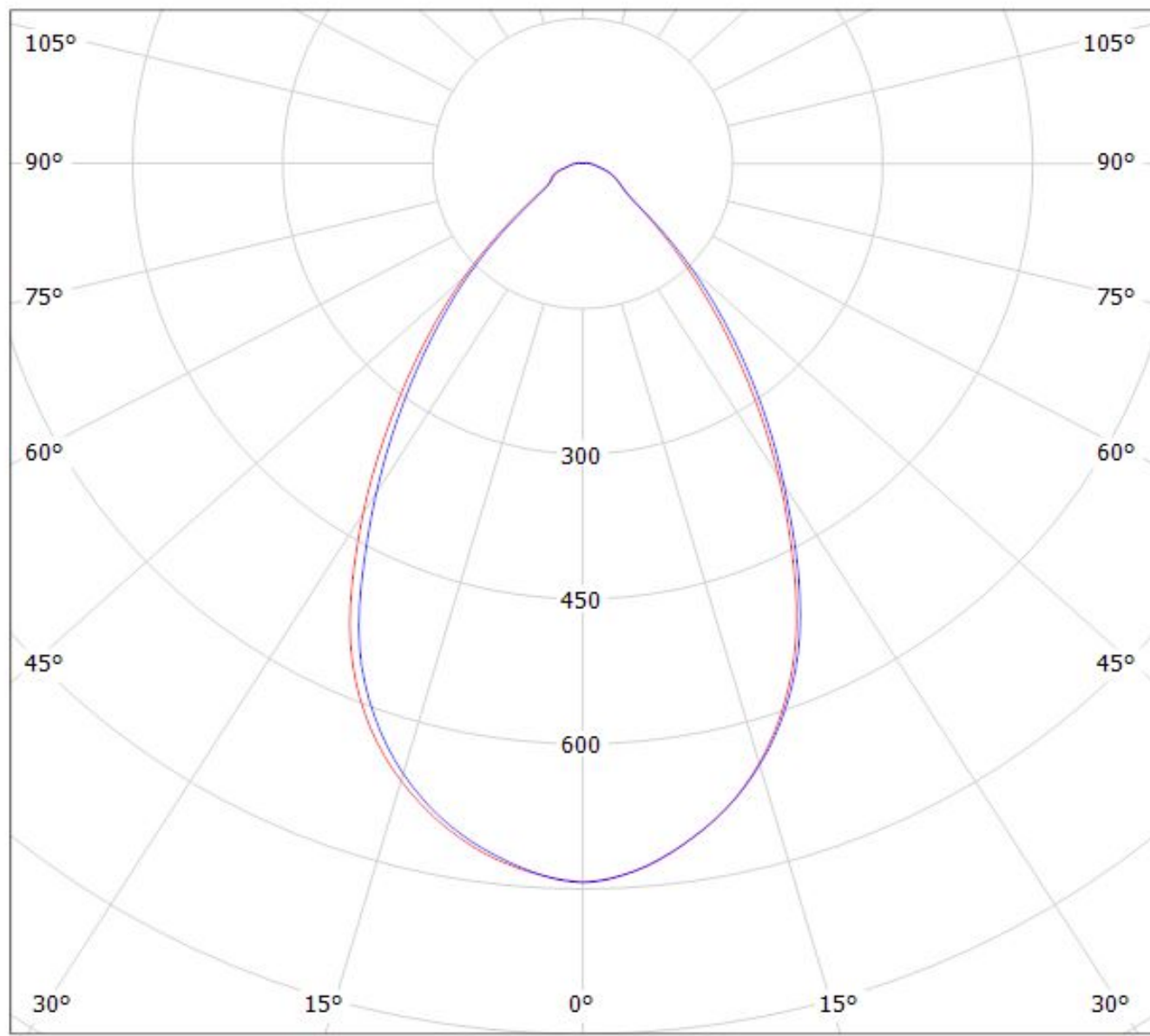

cd/klm

— C0 - C180

— C90 - C270

$\eta = 94\%$

Ledil FN14074_STELLA-HB_(CLU044)_(431_Typ_L3) / LDC (Polar)

Luminaire: Ledil FN14074_STELLA-HB_(CLU044)_(431_Typ_L3)

Lamps: 1 x Citizen_CLU044_(CLU044-1212B8-303M1A2)_1334.99lm@250mA_P=8.16W_I=0.25A

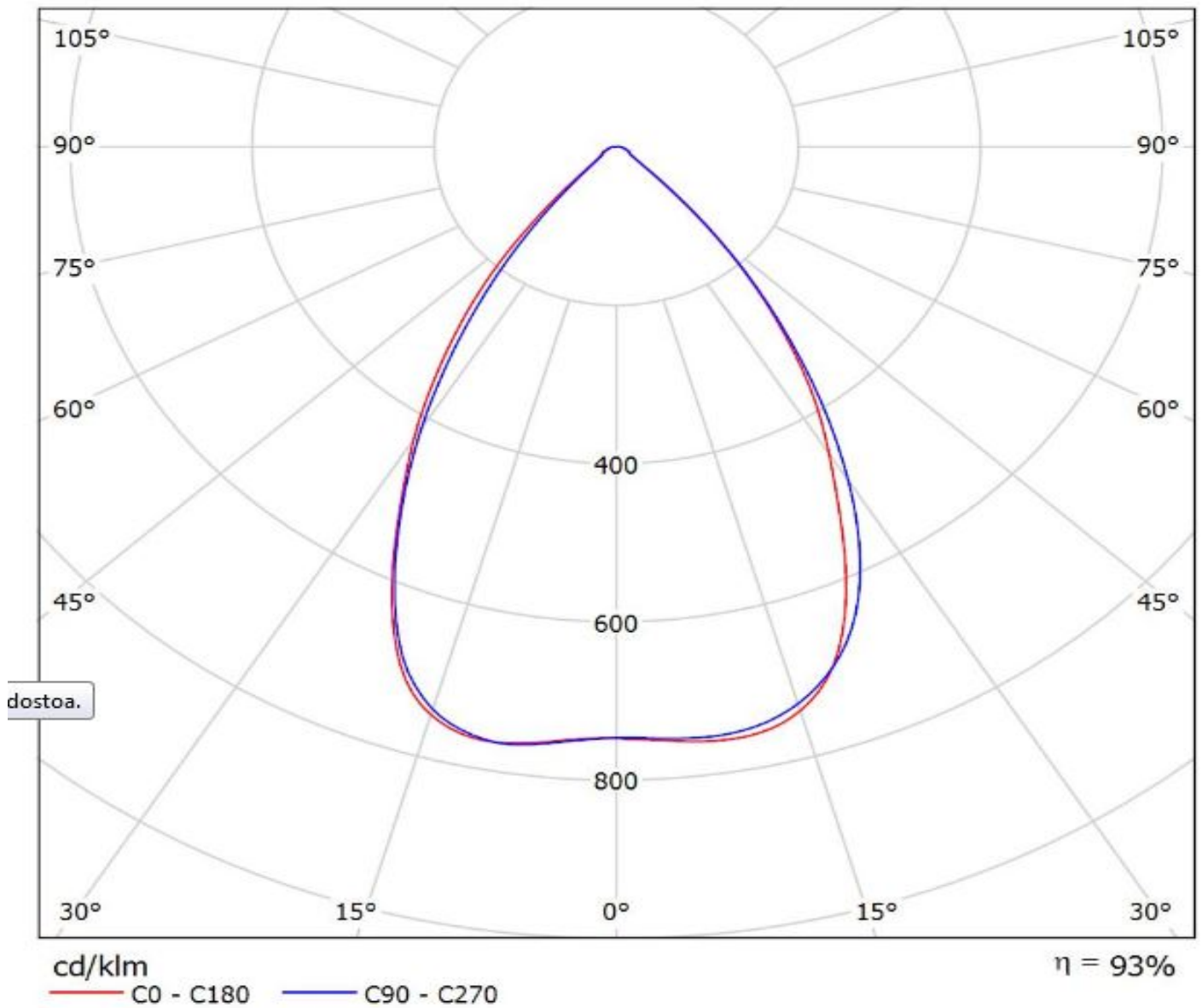

Luminaire: LEDiL Oy FN14074_STELLA-HB_(CXA3050)

Lamps: 1 x Cree_CXA30_(CXA3050-3C0-Y2-N0H)_1369.14lm@250mA_CCT=5000K_P=8.14498W_I=249.8mA

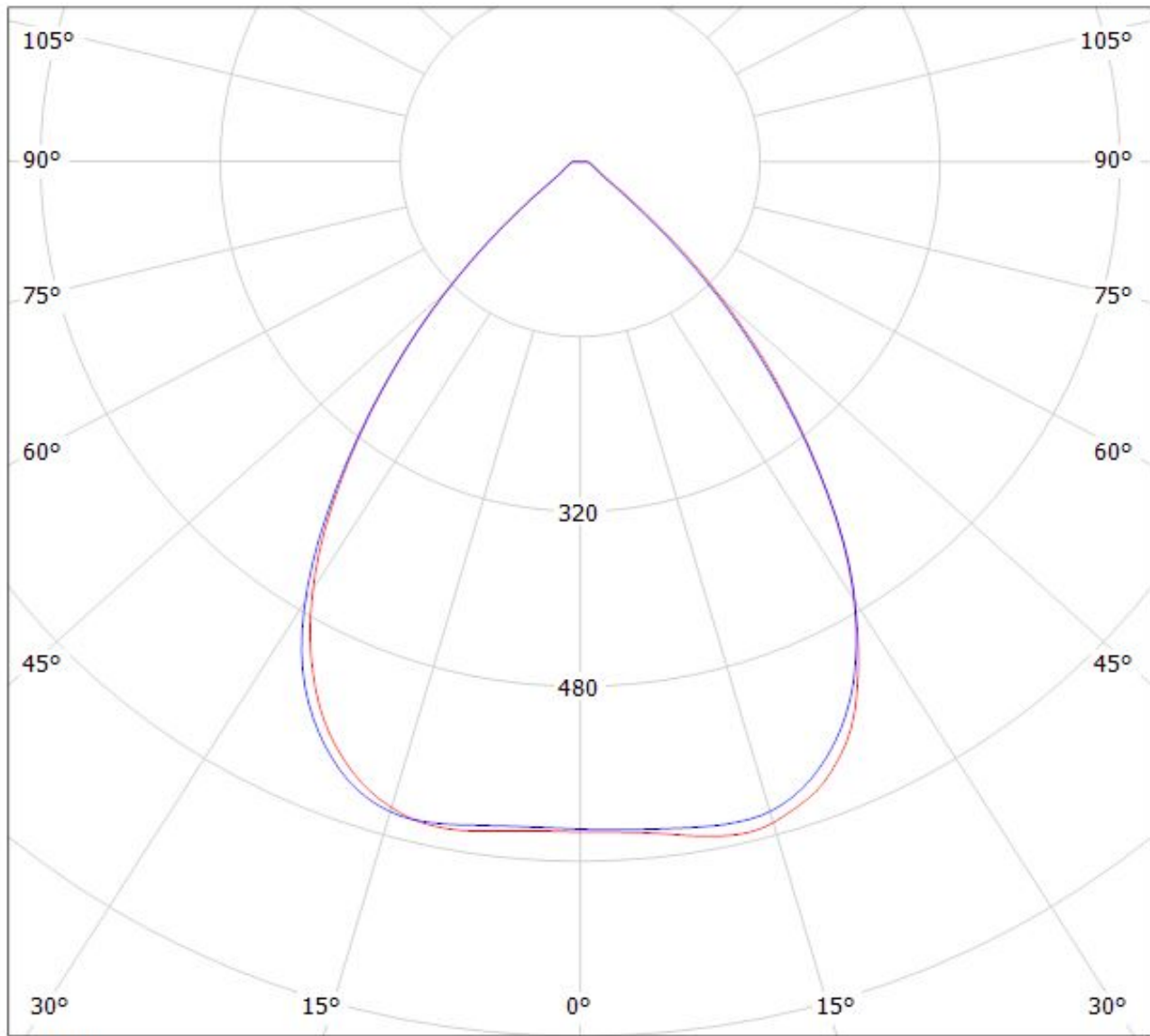

cd/klm

— C0 - C180

— C90 - C270

$\eta = 93\%$

Luminaire: LEDiL Oy FN14074_STELLA-HB_(CXA25)

Lamps: 1 x CREE_CXA25_(2520-7A-N4-N0U)_872.554lm@250mA_CCT=3000K_P=8.53567W_I=249.8mA

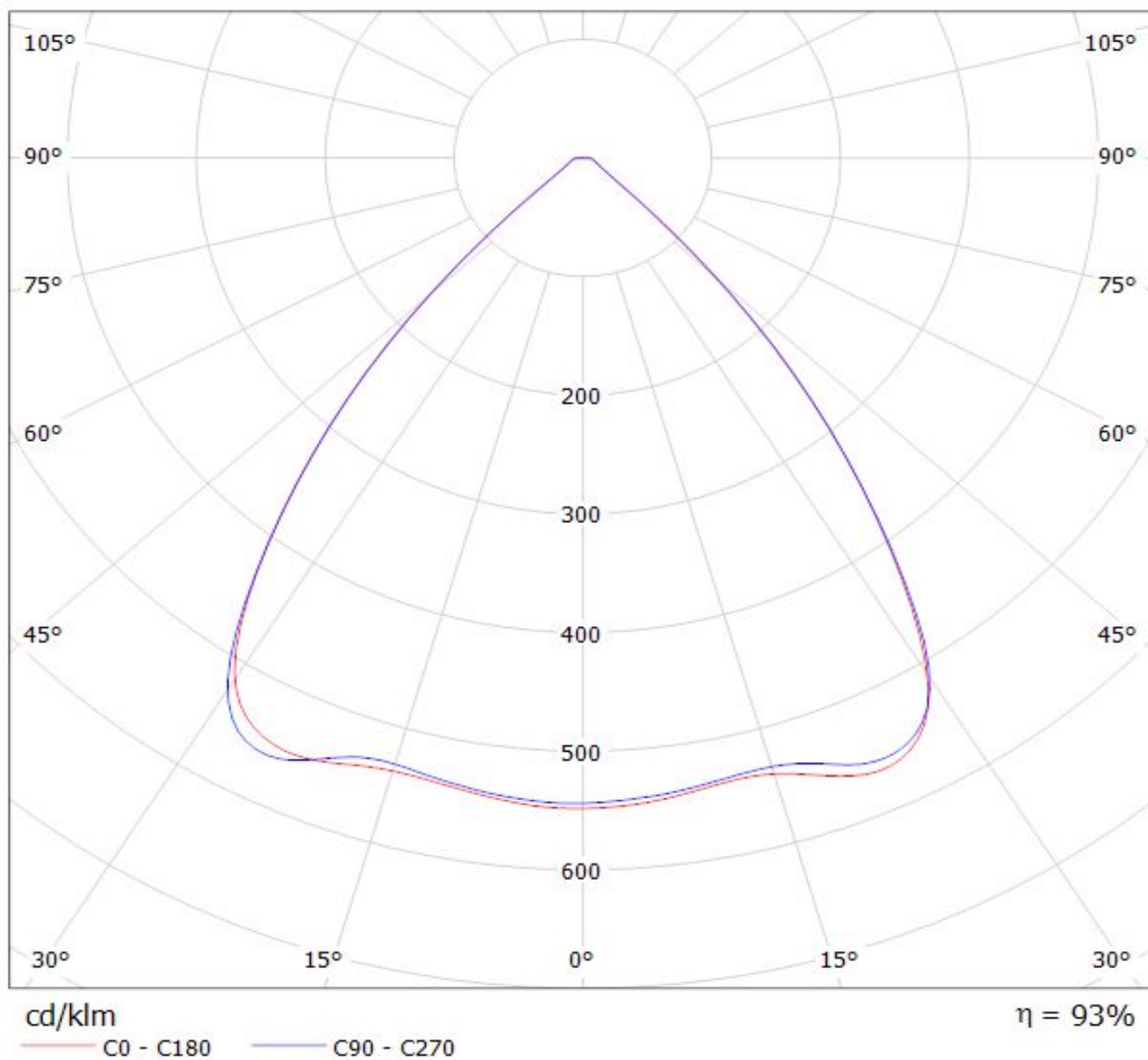

Luminaire: LEDiL Oy FN14074_STELLA-HB_(CXA3590)

Lamps: 1 x Cree_CXA3590_(CXA3590-30F-BD-R0H-0002)_2639.65lm@250mA_CCT=3000K_P=16.3039W_I=249.8mA

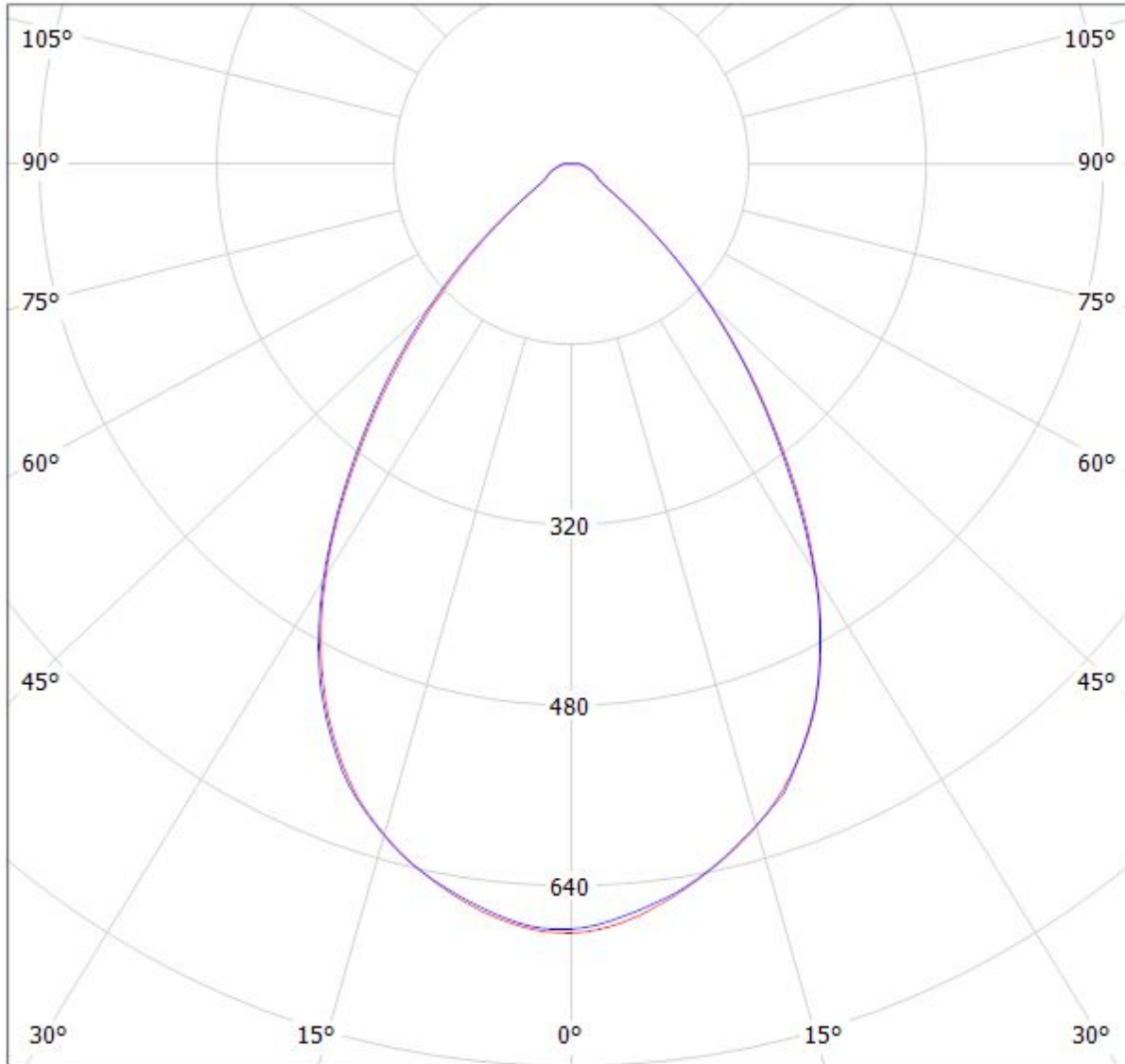

cd/klm

— C0 - C180 — C90 - C270

$\eta = 93\%$

Ledil FN14074_STELLA-HB_(CoB_1211)_(431_Typ_L3) / LDC (Polar)

Luminaire: Ledil FN14074_STELLA-HB_(CoB_1211)_(431_Typ_L3)

Lamps: 1 x Luxeon_CoB_1211_(LHC1-2790-1211)_952.748lm@250mA_P=8W_I=0.25A

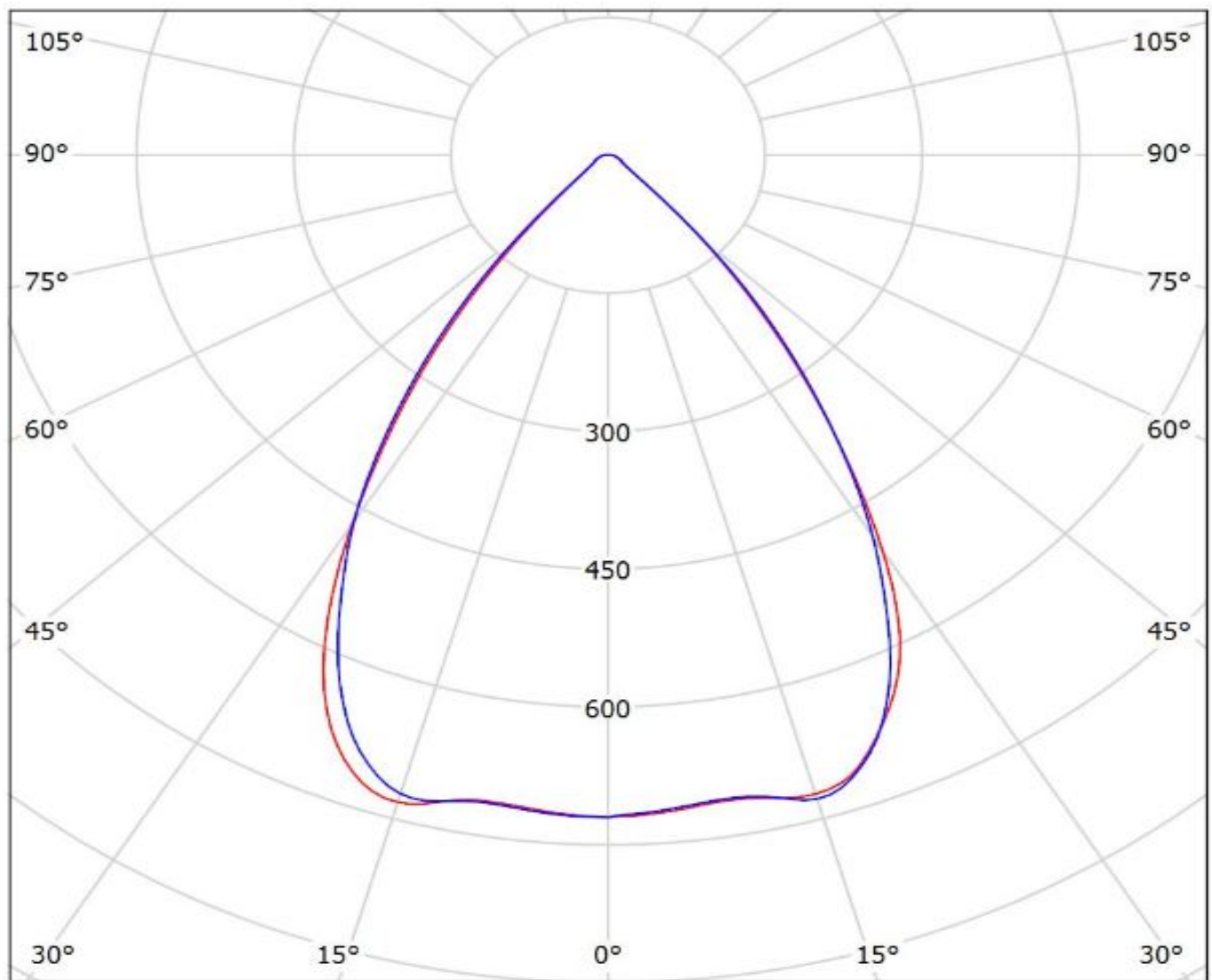

cd/klm

— C0 - C180

— C90 - C270

$\eta = 93\%$

Luminaire: Ledil FN14074_STELLA-HB_(CoB_1216)

Lamps: 1 x Luxeon_CoB_1216_(L2C2-40801216E2300)_1468.12lm@250mA_P=7.9868W_I=0.25A

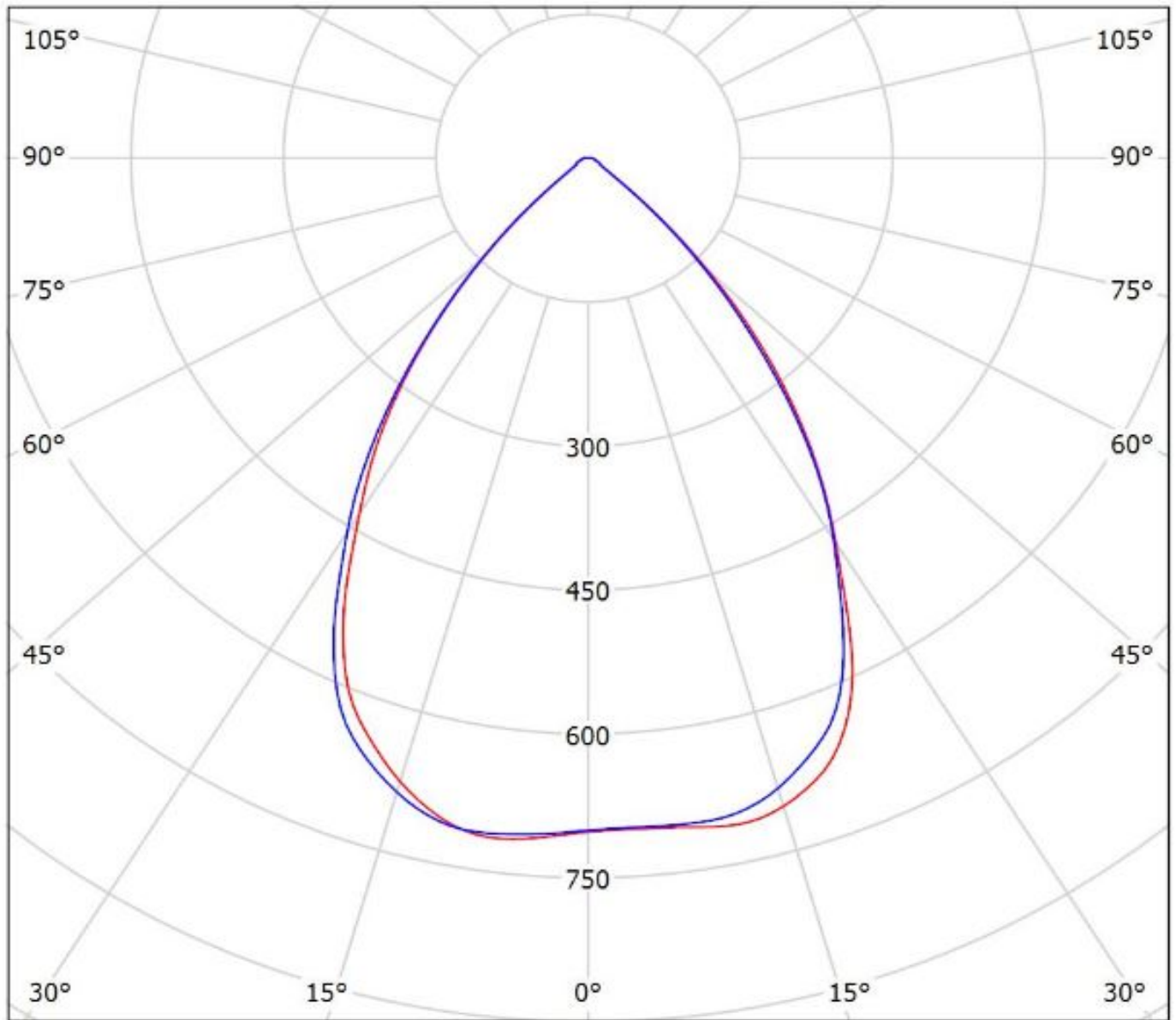

cd/klm

— C0 - C180 — C90 - C270

$\eta = 94\%$

Luminaire: LEDiL Oy FN14074_STELLA-HB_(CXM-18) Eff.92.8%

Lamps: 1 x LUMINUS_XNOVA_CXM-18_897.842lm@250mA_P=8.12425W_I=249.9mA

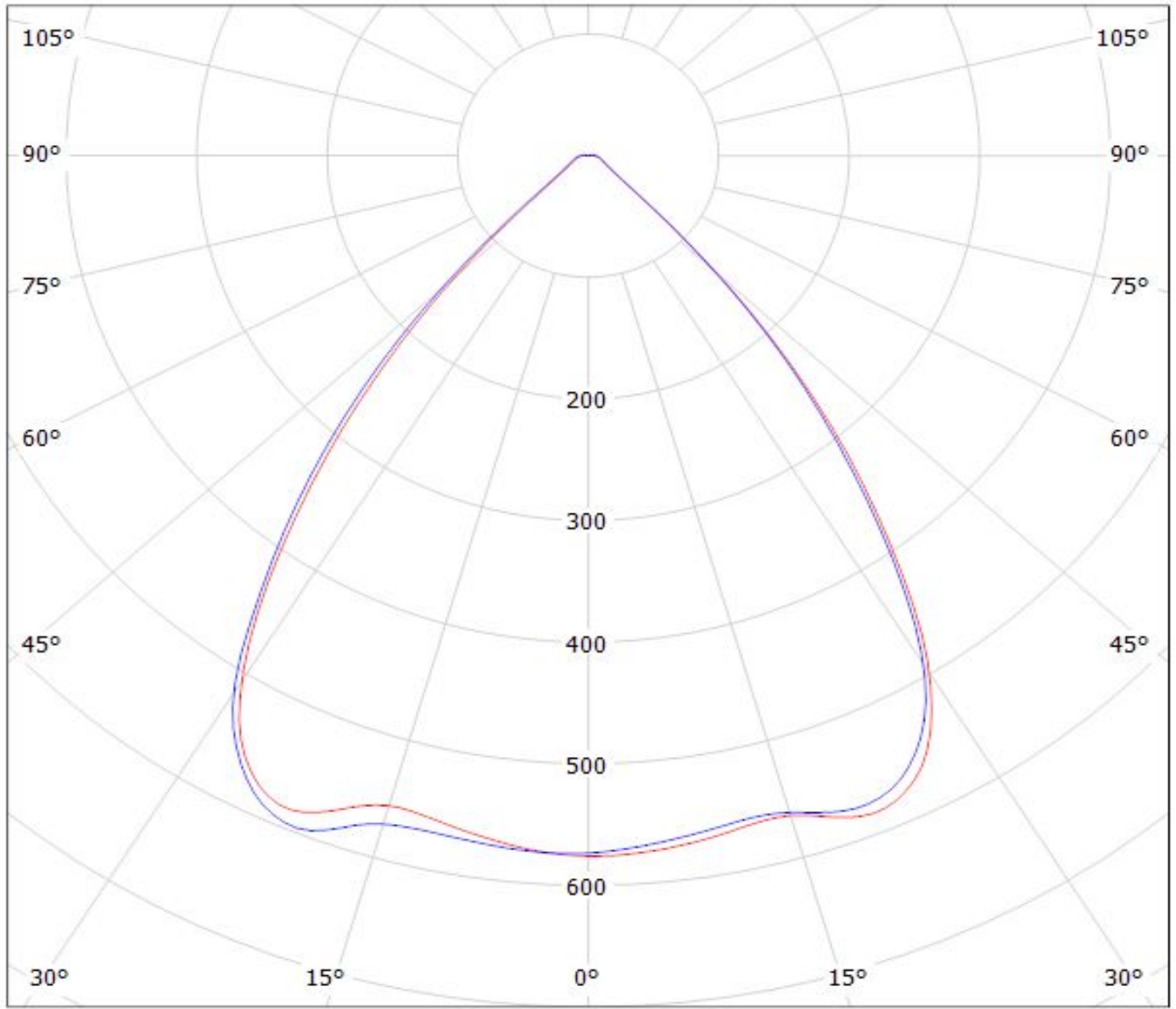

cd/klm

— C0 - C180

— C90 - C270

$\eta = 93\%$

Luminaire: LEDiL Oy FN14074_STELLA-HB_(SOLERIQ_S19) Eff.92.3%
Lamps: 1 x OSRAM_SOLERIQ_S19_(GW_KAHJB1.EM)
_1401.57lm@250mA_CCT=3000K_P=10.4274W_I=249.8mA

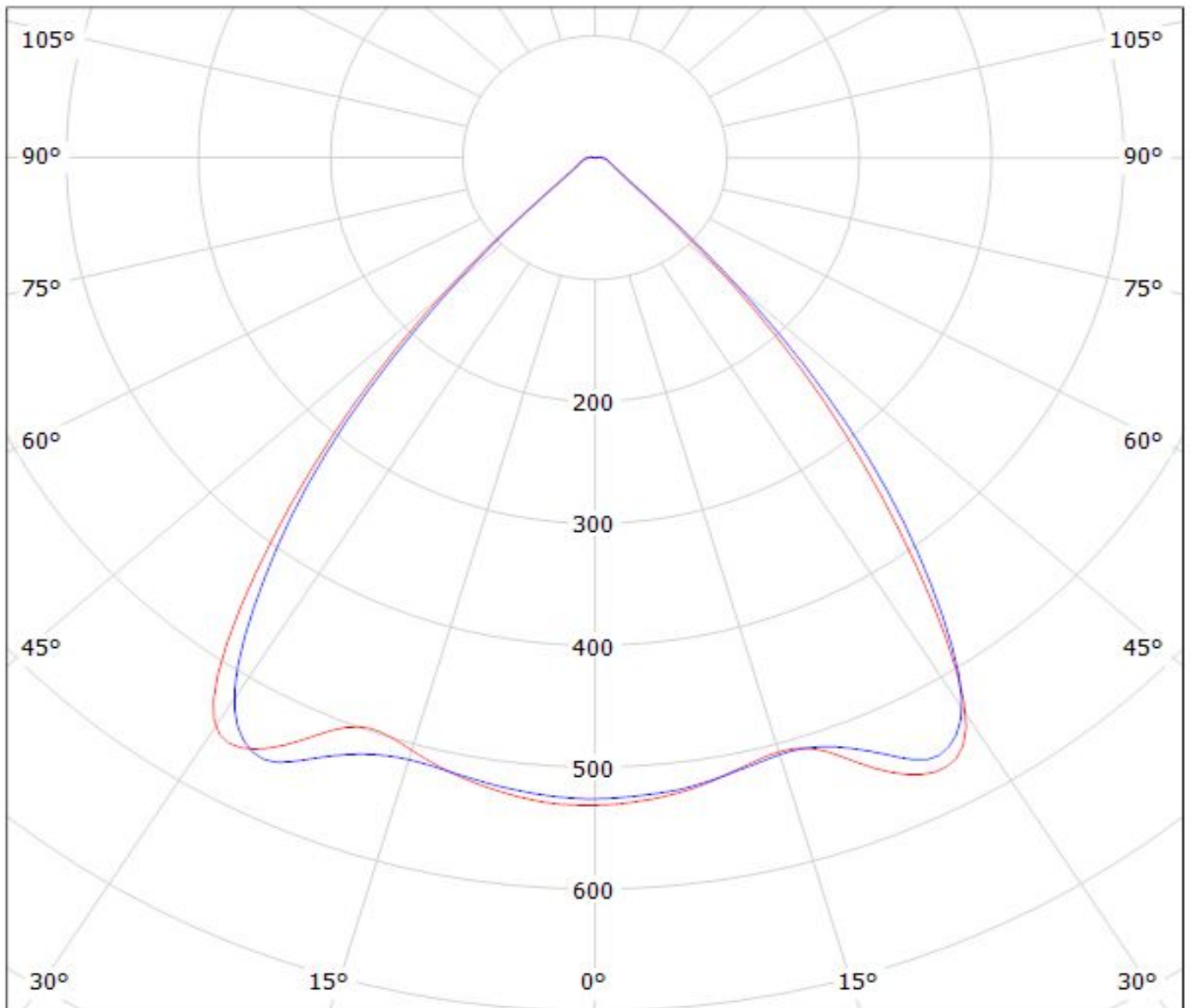

cd/klm

$\eta = 92\%$

— C0 - C180 — C90 - C270

Luminaire: Ledil FN14074_STELLA-HB_(MJT_180W_Les32,8)_+458TypL4

Lamps: 1 x Seoul_MJT_180W_Les32,8mm_(SAWx33GCA)_+458TypL4_3749.72lm@250mA_P=20.9727W_I=0.25A

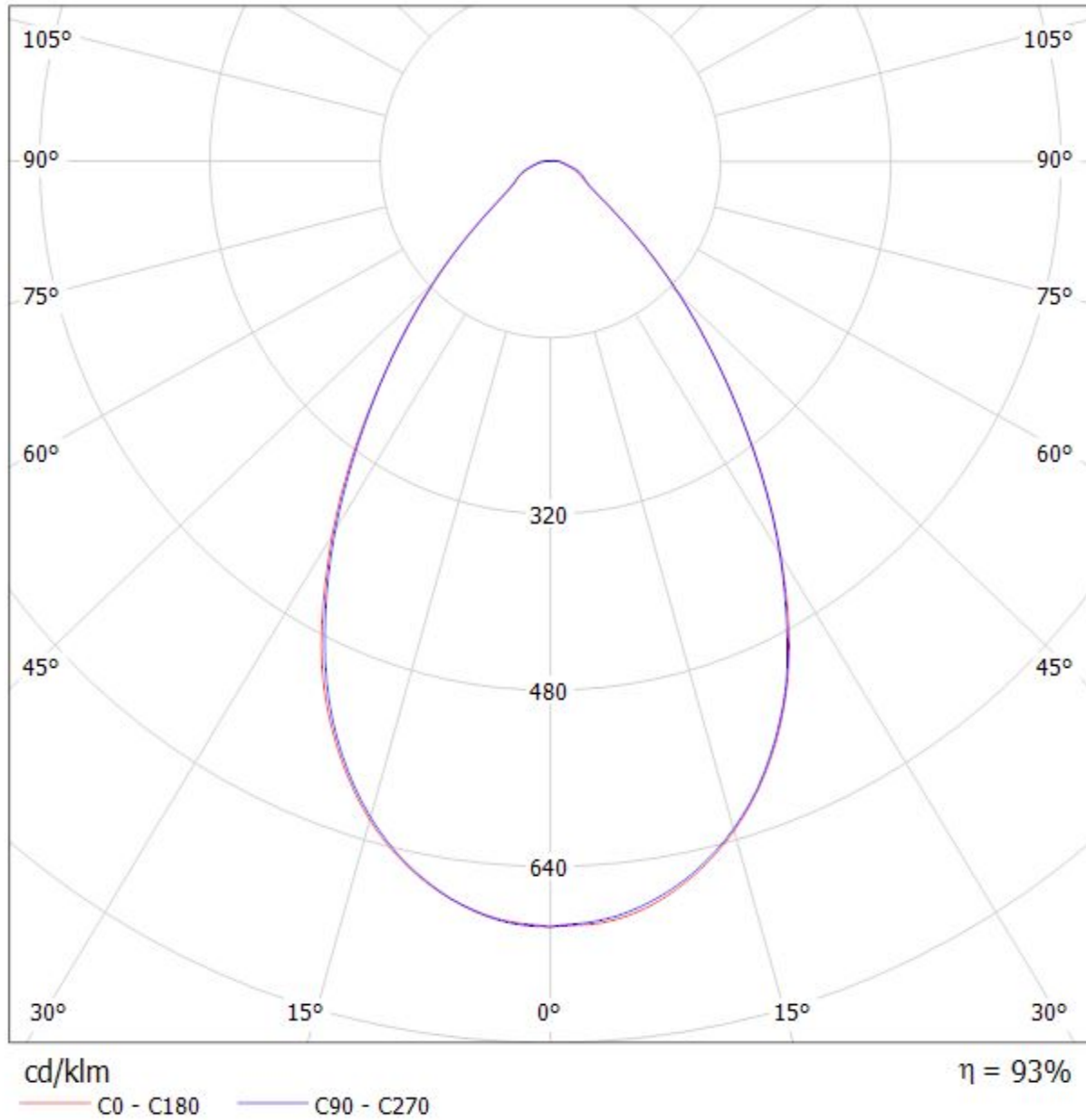

NOTE: The typical divergence will be changed by different color, chip size and chip position tolerance. The typical total divergence is the full angle measured where the luminous intensity is half of the peak value.

GENERAL INFORMATION

- Product series especially designed & optimized for series of LEDs.
- Special care taken to make light distribution as uniform as possible.

Note! Due to use of high power COB's with this product, special attention to proper thermal design is highly recommended. LEDiL has no liability for direct, indirect or consecutive damages arising from the LEDiL products being used outside of the recommended temperature range.