

MODEL PAXDP – 1/8 DIN DUAL PROCESS INPUT METER



- ACCEPTS TWO 4 - 20 MA OR 0 - 10 VDC INPUT SIGNALS
- PROGRAMMABLE A/D CONVERSION RATE, 5 TO 105 READINGS PER SECOND
- 5-DIGIT 0.56" RED SUNLIGHT READABLE DISPLAY
- VARIABLE INTENSITY DISPLAY
- LINEARIZATION/SQUARE ROOT EXTRACTION INPUT RANGE
- PROGRAMMABLE FUNCTION KEYS/USER INPUTS
- 9 DIGIT TOTALIZER (INTEGRATOR) WITH BATCHING
- OPTIONAL CUSTOM UNITS OVERLAY W/BACKLIGHT
- FOUR SETPOINT ALARM OUTPUTS (W/OPTION CARD)
- COMMUNICATION AND BUS CAPABILITIES (W/OPTION CARD)
- RETRANSMITTED ANALOG OUTPUT (W/OPTION CARD)
- NEMA 4X/IP65 SEALED FRONT BEZEL
- PC SOFTWARE AVAILABLE FOR METER CONFIGURATION

GENERAL DESCRIPTION

The PAXDP Dual Process Input Meter offers many features and performance capabilities to suit a wide range of industrial applications. Available in two models, AC or DC power, the meter has the capability to accept two, 4 to 20 mA or 0 to 10 VDC input signals. Each input signal can be independently scaled and displayed. In addition, a math function can be performed on the two signals, C + A + B, C - A - B, C + A - B, AB / C, CA / B, or C (A / B - 1). Any of the three meter values can have Alarms, Comms, and/or a Retrmitted Analog Output capability by simply adding optional cards. The optional output cards allow the opportunity to configure the meter for current applications, while providing easy upgrades for future needs.

The update rate of the meter is user selectable. This will help in those applications where a quick response from the meter is of the utmost importance. The rate can be adjusted from eight selections with a minimum of 5 updates/second to a maximum of 105 updates/second.

The meters employ a bright 0.56" (14.2 mm) red sunlight readable LED display. The intensity of display can be adjusted from dark room applications up to sunlight readable, making it ideal for viewing in bright light applications.

The meters provide a MAX and MIN reading memory with programmable capture time. The capture time is used to prevent detection of false max or min readings which may occur during start-up or unusual process events.

The signal totalizer (integrator) can be used to compute a time-input product. This can be used to provide a readout of totalized flow, calculate service intervals of motors or pumps, etc. The totalizer can also accumulate batch operations.

Optional digital output cards provide the meter with up to four setpoint outputs. The cards are available as dual relay, quad relay, quad sinking transistor, quad sourcing transistor/SSR drive, or dual triac/dual SSR drive outputs. The setpoint alarms can be configured to suit a variety of control and alarm requirements.

Communication and Bus Capabilities are also available as option cards. The standard output is in Modbus Protocol. Any of the following option cards,

RS232, RS485, DeviceNet, or Profibus can be used with the meter. Readout values and setpoint alarm values can be controlled through the bus. Additionally, the meters have a feature that allows a remote computer to directly control the outputs of the meter.

A linear DC output signal is available as an option card. The card provides either 20 mA or 10 V signals. The output can be scaled independent of the input range and can track either the input, totalizer, max/min readings, or math calculation value.

Once the meters have been initially configured, the parameter list may be locked out from further modification in its entirety or only the setpoint values can be made accessible.

The meters have been specifically designed for harsh industrial environments. With NEMA 4X/IP65 sealed bezel and extensive testing of noise effects to CE requirements, the meter provides a tough yet reliable application solution.

SAFETY SUMMARY

All safety related regulations, local codes and instructions that appear in this literature or on equipment must be observed to ensure personal safety and to prevent damage to either the instrument or equipment connected to it. If equipment is used in a manner not specified by the manufacturer, the protection provided by the equipment may be impaired.

Do not use this unit to directly command motors, valves, or other actuators not equipped with safeguards. To do so can be potentially harmful to persons or equipment in the event of a fault to the unit.



CAUTION: Risk of Danger.
 Read complete instructions prior to installation and operation of the unit.



CAUTION: Risk of electric shock.

DIMENSIONS In inches (mm)

Note: Recommended minimum clearance (behind the panel) for mounting clip installation is 2.1" (53.4) H x 5.0" (127) W.

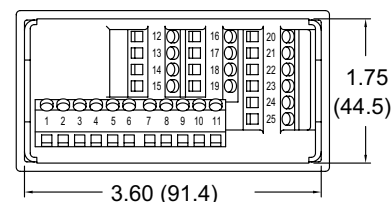
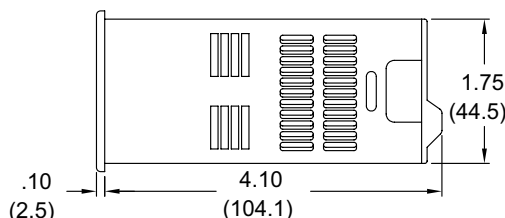
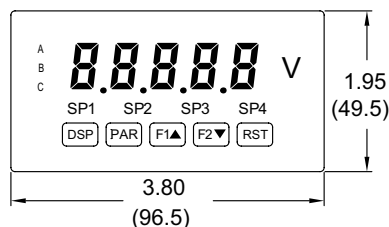
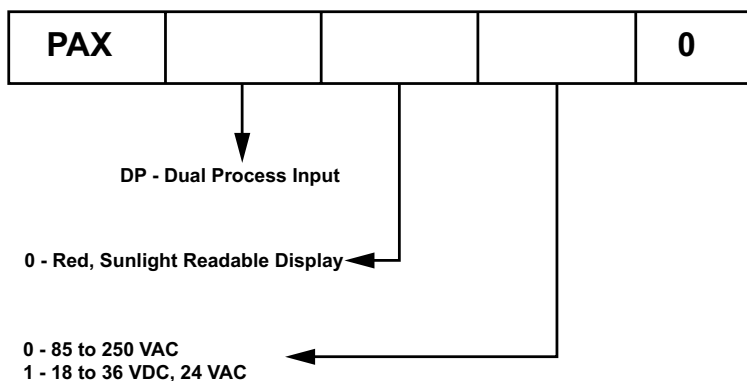

TABLE OF CONTENTS

Ordering Information	2	3.0 Installing Option Cards	7
Using This Manual	3	4.0 Wiring the Meter	7
Crimson Programming Software	3	5.0 Reviewing the Front Buttons and Display	9
General Meter Specifications	4	6.0 Programming the Meter	10
Option Cards	5	6.9 Factory Service Operations (9-FL5)	28
Accessories	6	Troubleshooting	29
1.0 Installing the Meter	6	Parameter Value Chart	29
2.0 Setting the Jumpers	6	Programming Quick Overview	31

ORDERING INFORMATION

Meter Part Numbers



Option Card and Accessories Part Numbers

TYPE	MODEL NO.	DESCRIPTION	PART NUMBER
Option Cards	PAXCDS	Dual Setpoint Relay Output Card	PAXCDS10
		Quad Setpoint Relay Output Card	PAXCDS20
		Quad Setpoint Sinking Open Collector Output Card	PAXCDS30
		Quad Setpoint Sourcing Open Collector Output Card	PAXCDS40
		Dual Triac/Dual SSR Drive Output Card	PAXCDS50
		Quad Form C Relay Output Card	PAXCDS60 *
	PAXCDC ¹	RS485 Serial Communications Card with Terminal Block	PAXCDC10
		Extended RS485 Serial Communications Card with Dual RJ11 Connector	PAXCDC1C
		RS232 Serial Communications Card with Terminal Block	PAXCDC20
		Extended RS232 Serial Communications Card with 9 Pin D Connector	PAXCDC2C
		DeviceNet Communications Card	PAXCDC30
		Profibus-DP Communications Card	PAXCDC50
	PAXCDL	Analog Output Card	PAXCDL10
	PAXUSB	PAX USB Programming Card	PAXUSB00
Accessories	CBLUSB	USB Programming Cable Type A-Mini B	CBLUSB01
	ICM8	Ethernet Gateway	ICM80000
	PAXLBK	Units Label Kit Accessory	PAXLBK10
	SFCRD ♦	Crimson 2 Programming Software (for Windows OS)	SFCRD200

Notes:

¹. For Modbus communications use RS485 Communications Option Card and configure communication (**TYPE**) parameter for Modbus.

* This card is not suitable for use in older PAX models. For proper installation, a case knock-out feature must be present on the top surface of the PAX case. This feature began to be introduced to the standard PAX units in July of 2014 (2614).

♦ Crimson® software is available for free download from <http://www.redlion.net/>

USING THIS MANUAL

This manual contains installation and programming instructions for the PAX and all applicable option cards. To make installing the option card easier, it is recommended to use the Installation Guide provided with the card.

Only the portions of this manual that apply to the application need to be read. Minimally, we recommend that General Specifications, Reviewing the Front Buttons and Display, and Crimson® Programming Software portions of this manual be read in their entirety.

We recommend that unit programming be performed using Crimson programming software. When using Crimson, the programming portion of this manual serves as an overview of the programming options that are available through Crimson. The programming section of the manual will serve to provide

expanded explanations of some of the PAX programming features found in Crimson. For users who do not intend to use Crimson to program their unit, this manual includes information to provide for a user to program one, or all, of the programming parameters using the unit's keypad.

To find information regarding a specific topic or mnemonic, it is recommended that the manual be viewed on a computer and the "find" function be used. The alternate method of finding information is to identify the programming parameter involved and review the information contained in the section of the manual that pertains to that parameter.

CRIMSON PROGRAMMING SOFTWARE

Crimson® software is a Windows® based program that allows configuration of the PAX® meter from a PC. Crimson offers standard drop-down menu commands, that make it easy to program the controller. The unit's program can then be saved in a PC file for future use.

PROGRAMMING USING CRIMSON:

Download or check for updates to Crimson at <http://www.redlion.net/crimson2>.

- Install Crimson. Follow the installation instructions provided by the source from which Crimson is being downloaded or installed.
- Install an appropriate communication option card (PAXUSB00, PAXCDC1x, or PAXCDC2x) in the PAX and make necessary wiring connections from communication card to the PC. Note that only one PAX unit can be programmed at a time.
- Apply appropriate power to the PAX.
- Start Crimson.
- Select "Link" tab, then select "Options..." to configure/verify Communications Port. Configure PAXDP serial settings for: Modbus RTU, 38400, No Parity, and address 247.
- Select "File" tab, then click on "New". Select "PAX Panel Meters" under the Product Family selection and then select the PAX model and version according to the PAX unit to be programmed. Click "OK".
- A programming selection screen will appear. Double click on an applicable programming selection and make program specific parameter selections. When completed, click "Close" and continue selecting applicable programming selections and making appropriate parameter selections. Continue until all necessary programming parameters have been configured. Hovering the cursor over a parameter selection will often provide a description of the parameter. For additional information regarding a parameter selection, see the PAX user manual.
- When all programming configuration selections have been completed, save the configuration file.
- Download the configuration file to the PAX by clicking the "Link" tab and then selecting "Update".

GENERAL METER SPECIFICATIONS

1. **DISPLAY:** 5 digit, 0.56" (14.2 mm) variable intensity red sunlight readable (-19999 to 99999)

2. **POWER:**

AC Versions:

AC Power: 85 to 250 VAC, 50/60 Hz, 21 VA
Isolation: 2300 Vrms for 1 min. to all inputs and outputs.

DC Versions: (Derate operating temperature to 40° C if three option cards or PAXCDC50 are installed.)

DC Power: 18 to 36 VDC, 13 W
AC Power: 24 VAC, ± 10%, 50/60 Hz, 16 VA
Isolation: 500 Vrms for 1 min. to all inputs and outputs.
Must use a Class 2 or SELV rated power supply

3. **ANNUNCIATORS:**

A - Programmable Display
B - Programmable Display
C - Programmable Display
SP1 - Setpoint alarm 1 is active
SP2 - Setpoint alarm 2 is active
SP3 - Setpoint alarm 3 is active
SP4 - Setpoint alarm 4 is active
Units Label - Optional units label backlight

4. **KEYPAD:** 3 programmable function keys, 5 keys total

5. **A/D CONVERTER:** 16 bit resolution

6. **UPDATE RATES:**

A/D conversion rate: Adjustable 5.3 to 105 readings/sec.
Step response: (to within 99% of final readout value with digital filter disabled)

INPUT UPDATE RATE	MAX. TIME (msec)
5.3	770
7.5	560
16.7	260
19.8	220
20	220
30	150
105	60

Display update rate: adjustable 1 to 20 readings/sec.

Setpoint output on/off delay time: 0 to 3275 sec.

Analog output update rate: 0 to 10 sec

Max./Min. capture delay time: 0 to 3275 sec.

7. **DISPLAY MESSAGES:**

“OLOL” - Appears when measurement exceeds + signal range.
“ULUL” - Appears when measurement exceeds - signal range
“. . .” - Appears when display values exceed + display range.
“- . .” - Appears when display values exceed - display range.

8. **SENSOR INPUTS:**

INPUT (RANGE)	ACCURACY* (18 to 28°C)	ACCURACY* (0 to 50°C)	IMPEDANCE/ COMPLIANCE	MAX CONTINUOUS OVERLOAD	DISPLAY RESOLUTION
±20 mA (-26 to 26 mA)	0.03% of reading +2 µA	0.12% of reading +3 µA	24.6 ohm	90 mA	1 µA
±10 VDC (-13 to 13 VDC)	0.03% of reading +2 mV	0.12% of reading +3 mV	500 Kohm	50 V	1 mV

* After 20 minute warm-up. Accuracy is specified in two ways: Accuracy over an 18 to 28°C and 10 to 75% RH environment; and accuracy over a 0 to 50°C and 0 to 85% RH (non-condensing environment). Accuracy over the 0 to 50°C range includes the temperature coefficient effect of the meter.

9. **EXCITATION POWER:**

Transmitter Power: 18 VDC, ±20%, unregulated, 70 mA max. per input channel.

10. **LOW FREQUENCY NOISE REJECTION:**

Normal Mode: (digital filter off)

INPUT UPDATE RATE	50 Hz ±1 Hz	60 Hz ±1 Hz
5.3	>90 dB	>65 dB
7.5	>60 dB	>55 dB
16.7	>100 dB	>50 dB
19.8*	>60 dB	>95 dB
20	>55 dB	>100 dB
30	>20 dB	>20 dB
105	>20 dB	>13 dB

*Note: 19.8 Hz Input Rate provides best rate performance and simultaneous 50/60 Hz rejection.

Common Mode: >100 dB @ 50/60 ±1 Hz (19.8 or 20 Input Rate)

11. **USER INPUTS:** Three programmable user inputs

Max. Continuous Input: 30 VDC

Isolation To Sensor Input A Common: 500 Vrms for 1 min.

Isolation To Sensor Input B Common: Not isolated.

INPUT STATE	SINKING INPUTS 22 KΩ pull-up to +5 V	SOURCING INPUTS 22 KΩ pull-down
Active	$V_{IN} < 0.9$ VDC	$V_{IN} > 3.6$ VDC
Inactive	$V_{IN} > 3.6$ VDC	$V_{IN} < 0.9$ VDC

Response Time: 20 msec. max.

Logic State: Jumper selectable for sink/source logic

12. **TOTALIZER:**

Function:

Time Base: second, minute, hour, or day

Batch: Can accumulate (gate) input display from a user input

Time Accuracy: 0.01% typical

Decimal Point: 0 to 0.0000

Scale Factor: 0.001 to 65,000

Low Signal Cut-out: -19,999 to 99,999

Total: 9 digits, display alternates between high order and low order readouts

13. **CUSTOM LINEARIZATION:**

Data Point Pairs: Selectable from 2 to 16

Display Range: -19,999 to 99,999

Decimal Point: 0 to 0.0000

14. **MEMORY:** Nonvolatile memory retains all programmable parameters and display values.

15. **CERTIFICATIONS AND COMPLIANCES:**

CE Approved

EN 61326-1 Immunity to Industrial Locations

Emission EN 55011 Class A

IEC/EN 61010-1

UL Recognized Component: File #E179259

UL Listed: File #E137808

Type 4X Enclosure rating (Face only)

IP65 Enclosure rating (Face only)

IP20 Enclosure rating (Rear of unit)

Refer to EMC Installation Guidelines section of the bulletin for additional information.

16. **ENVIRONMENTAL CONDITIONS:**

Operating Temperature Range: 0 to 50°C

Storage Temperature Range: -40 to 60°C

Vibration to IEC 68-2-6: Operational 5-150 Hz, 2 g

Shock to IEC 68-2-27: Operational 25 g (10 g relay)

Operating and Storage Humidity: 0 to 85% max. RH non-condensing

Altitude: Up to 2000 meters

17. **CONNECTIONS:** High compression cage-clamp terminal block

Wire Strip Length: 0.3" (7.5 mm)

Wire Gauge: 30-14 AWG copper wire

Torque: 4.5 inch-lbs (0.51 N-m) max.

18. **CONSTRUCTION:** This unit is rated for NEMA 4X/IP65 outdoor use.

IP20 Touch safe. Installation Category II, Pollution Degree 2. One piece bezel/case. Flame resistant. Synthetic rubber keypad. Panel gasket and mounting clip included.

19. **WEIGHT:** 10.4 oz. (295 g)

OPTION CARDS



WARNING: Disconnect all power to the unit before installing option cards.

Adding Option Cards

The PAX and MPAX series meters can be fitted with up to three option cards. The details for each option card can be reviewed in the specification section below. Only one card from each function type can be installed at one time. The function types include Setpoint Alarms (PAXCDS), Communications (PAXCDC or PAXUSB), and Analog Output (PAXCDL). The option cards can be installed initially or at a later date.

COMMUNICATION CARDS (PAXCDC)

A variety of communication protocols are available for the PAX and MPAX series. Only one of these cards can be installed at a time. When programming the unit via Crimson, a Windows® based program, a USB, RS232 or RS485 Card must be used.

SERIAL COMMUNICATIONS CARD: PAXCDC1_ and PAXCDC2_

Type: RS485 or RS232

Communication Type: RLC Protocol (ASCII), Modbus RTU, and Modbus ASCII

Isolation To Sensor & User Input Commons: 500 Vrms for 1 min.

Not Isolated from all other commons.

Baud: 300 to 38,400

Data: 7/8 bits

Parity: No, Odd or Even

Bus Address: Selectable 0 to 99 (RLC Protocol), or 1 to 247 (Modbus Protocol), Max. 32 meters per line (RS485)

Transmit Delay: Selectable for 0 to 0.250 sec (+2 msec min)

DEVICENET™ CARD: PAXCDC30

Compatibility: Group 2 Server Only, not UCMM capable

Baud Rates: 125 Kbaud, 250 Kbaud, and 500 Kbaud

Bus Interface: Phillips 82C250 or equivalent with MIS wiring protection per DeviceNet™ Volume I Section 10.2.2.

Node Isolation: Bus powered, isolated node

Host Isolation: 500 Vrms for 1 minute between DeviceNet™ and meter input common.

PROFIBUS-DP CARD: PAXCDC50

Fieldbus Type: Profibus-DP as per EN 50170, implemented with Siemens SPC3 ASIC

Conformance: PNO Certified Profibus-DP Slave Device

Baud Rates: Automatic baud rate detection in the range 9.6 Kbaud to 12 Mbaud

Station Address: 0 to 125, set by rotary switches.

Connection: 9-pin Female D-Sub connector

Network Isolation: 500 Vrms for 1 minute between Profibus network and sensor and user input commons. Not isolated from all other commons.

PAXUSB PROGRAMMING CARD: PAXUSB00

Type: USB Virtual Comms Port

Communication Type: RLC protocol (ASCII), Modbus RTU, and Modbus ASCII.

Connection: Type mini B

Isolation To Sensor & User Input Commons: 500 Vrms for 1 min.

Not Isolated from all other commons.

Baud Rate: 300 to 38,400

Unit Address: Selectable 0 to 99 (RLC protocol) or 1 to 247 (Modbus protocol).

SETPOINT CARDS (PAXCDS)

The PAX and MPAX series has 6 available setpoint alarm output option cards. Only one of these cards can be installed at a time. (Logic state of the outputs can be reversed in the programming.)

DUAL RELAY CARD: PAXCDS10

Type: Two FORM-C relays

Isolation To Sensor & User Input Commons: 2000 Vrms for 1 min.

Contact Rating:

One Relay Energized: 5 amps @ 120/240 VAC or 28 VDC (resistive load).

Total current with both relays energized not to exceed 5 amps

Life Expectancy: 100 K cycles min. at full load rating. External RC snubber extends relay life for operation with inductive loads

QUAD RELAY CARD: PAXCDS20

Type: Four FORM-A relays

Isolation To Sensor & User Input Commons: 2300 Vrms for 1 min.

Contact Rating:

One Relay Energized: 3 amps @ 240 VAC or 30 VDC (resistive load)

Total current with all four relays energized not to exceed 4 amps

Life Expectancy: 100 K cycles min. at full load rating. External RC snubber extends relay life for operation with inductive loads

QUAD SINKING OPEN COLLECTOR CARD: PAXCDS30

Type: Four isolated sinking NPN transistors.

Isolation To Sensor & User Input Commons: 500 Vrms for 1 min.

Not Isolated from all other commons.

Rating: 100 mA max @ $V_{SAT} = 0.7 V$ max. $V_{MAX} = 30 V$

QUAD SOURCING OPEN COLLECTOR CARD: PAXCDS40

Type: Four isolated sourcing PNP transistors.

Isolation To Sensor & User Input Commons: 500 Vrms for 1 min.

Not Isolated from all other commons.

Rating: Internal supply: 24 VDC $\pm 10\%$, 30 mA max. total

External supply: 30 VDC max., 100 mA max. each output

DUAL TRIAC/DUAL SSR DRIVE CARD: PAXCDS50

Triac:

Type: Isolated, zero crossing detection

Voltage: 260 VAC max., 20 VAC min.

Max Load Current: 1 Amp @ 25°C
0.75 Amp @ 50°C

Total load current with both triacs ON not to exceed 1.5 Amps

Min Load Current: 5 mA

Off State Leakage Current: 1 mA max @ 60 Hz

Operating Frequency: 20-400 Hz

SSR Drive:

Type: Two isolated sourcing PNP Transistors.

Isolation To Sensor & User Input Commons: 500 Vrms for 1 min.

Not Isolated from all other commons.

Rating:

Output Voltage: 18/24 VDC (unit dependent) $\pm 10\%$, 30 mA max. total both outputs

QUAD FORM C RELAY CARD: PAXCDS60

Type: Four FORM-C relays

Isolation To Sensor & User Input Commons: 500 Vrms for 1 min.

Contact Rating:

Rated Load: 3 Amp @ 30 VDC/125 VAC

Total Current With All Four Relays Energized not to exceed 4 amps

Life Expectancy: 100 K cycles min. at full load rating. External RC snubber extends relay life for operation with inductive loads

ALL SETPOINT CARDS

Response Time: See update rates step response specification; add 6 msec (typical) for relay card

LINEAR DC OUTPUT (PAXCDL)

Either a 0(4)-20 mA or 0-10 V retransmitted linear DC output is available from the analog output option card. The programmable output low and high scaling can be based on various display values. Reverse slope output is possible by reversing the scaling point positions.

ANALOG OUTPUT CARD: PAXCDL10 - Self-Powered Output (Active)

Types: 0 to 20 mA, 4 to 20 mA or 0 to 10 VDC

Isolation To Sensor & User Input Commons: 500 Vrms for 1 min.

Not Isolated from all other commons.

Accuracy: 0.17% of FS (18 to 28°C); 0.4% of FS (0 to 50°C)

Resolution: 1/3500

Compliance: 10 VDC: 10 K Ω load min., 20 mA: 500 Ω load max.

Step Response: See update rates step response specification

Update time: See ADC Conversion Rate and Update Time parameter

ACCESSORIES

UNITS LABEL KIT (PAXLBK)

Each meter has a units indicator with backlighting that can be customized using the Units Label Kit. The backlight is controlled in the programming.

1.0 INSTALLING THE METER

Installation

The PAX meets NEMA 4X/IP65 requirements when properly installed. The unit is intended to be mounted into an enclosed panel. Prepare the panel cutout to the dimensions shown. Remove the panel latch from the unit. Slide the panel gasket over the rear of the unit to the back of the bezel. The unit should be installed fully assembled. Insert the unit into the panel cutout.

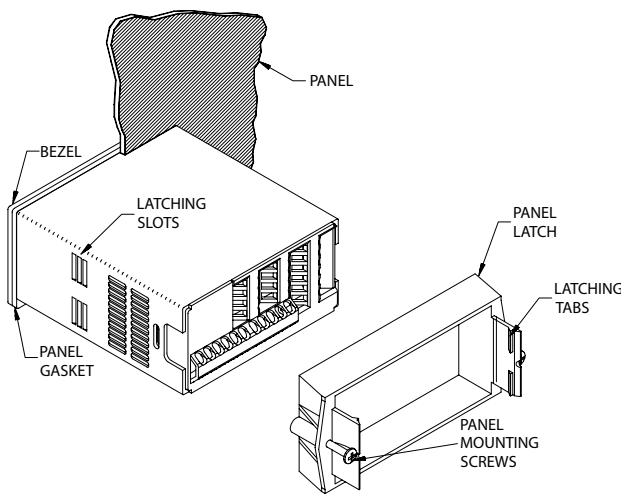

While holding the unit in place, push the panel latch over the rear of the unit so that the tabs of the panel latch engage in the slots on the case. The panel latch should be engaged in the farthest forward slot possible. To achieve a proper seal, tighten the latch screws evenly until the unit is snug in the panel (Torque to approximately 7 in-lbs [79N-cm]). Do not over-tighten the screws.

Installation Environment

The unit should be installed in a location that does not exceed the maximum operating temperature and provides good air circulation. Placing the unit near devices that generate excessive heat should be avoided.

The bezel should be cleaned only with a soft cloth and neutral soap product. Do NOT use solvents. Continuous exposure to direct sunlight may accelerate the aging process of the bezel.

Do not use tools of any kind (screwdrivers, pens, pencils, etc.) to operate the keypad of the unit.

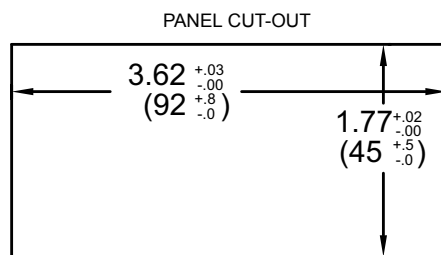

2.0 SETTING THE JUMPERS

The meter has three jumpers that must be checked and/or changed prior to applying power. The following Jumper Selection Figures show an enlargement of the jumper area.

To access the jumpers, remove the meter base from the case by firmly squeezing and pulling back on the side rear finger tabs. This should lower the latch below the case slot (which is located just in front of the finger tabs). It is recommended to release the latch on one side, then start the other side latch.

Input Jumpers

These jumpers are used to select the proper input types, Voltage (V) or Current (I). The input type selected in programming must match the jumper setting. See the Jumper Selection Figures for more details.

User Input Logic Jumper

This jumper selects the logic state of all the user inputs. If the user inputs are not used, it is not necessary to check or move this jumper.

PAXDP Jumper Selection

JUMPER SELECTIONS

The \curvearrowright indicates factory setting.

INPUT A	INPUT B	USER INPUT
VOLT/CURRENT	VOLT/CURRENT	
<input type="checkbox"/> — CURRENT (I)	<input type="checkbox"/> — CURRENT (I)	<input checked="" type="checkbox"/> — SINK
<input checked="" type="checkbox"/> — VOLTAGE (V)	<input checked="" type="checkbox"/> — VOLTAGE (V)	<input type="checkbox"/> — SOURCE (SRC)

Note: In the figures above, the text shown in parenthesis is printed on the circuit board to help with proper jumper positioning.

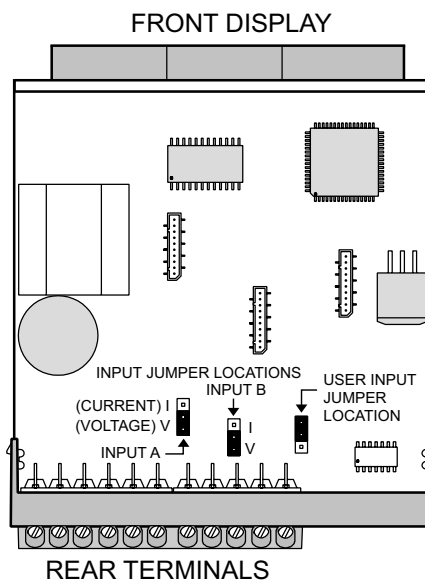

3.0 INSTALLING OPTION CARDS

The option cards are separately purchased optional cards that perform specific functions. These cards plug into the main circuit board of the meter. The option cards have many unique functions when used with the PAX.



CAUTION: The option and main circuit boards contain static sensitive components. Before handling the cards, discharge static charges from your body by touching a grounded bare metal object. Ideally, handle the circuit boards at a static controlled clean workstation. Dirt, oil or other contaminants that may contact the circuit boards can adversely affect circuit operation.

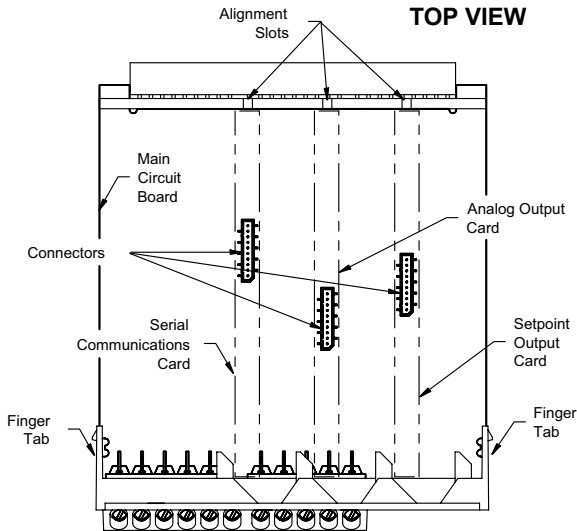

WARNING: Exposed line voltage will be present on the circuit boards when power is applied. Remove all power to the meter AND load circuits before accessing the meter.

To Install:

1. For option card specific installation instructions, see the installation instructions provided with the option card being installed.
2. When handling the main circuit board, hold it by the rear cover. When handling the option card, hold it by the terminal block.
3. Remove the main assembly from the rear of the case by squeezing both finger holds on the rear cover and pulling the assembly out of the case. Or use a small screwdriver to depress the side latches and pull the main assembly out of the case. Do not remove the rear cover from the main circuit board.
4. Locate the appropriate option card slot location on the main circuit board. Align the option card terminal block with the slot terminal block position on the rear cover. Align the option card connector with the main circuit board option card connector and then press to fully engage the connector. Verify the tab on the option card rests in the alignment slot on the display board.
5. If installing an option card that includes a terminal block on the top of the option card, a knock-out on the top of the PAX case will need to be removed to allow the top terminal block to be inserted later. Locate the  shaped knock-out that aligns with the option slot for which the option card is being installed. Carefully remove the knock-out, being careful not to remove additional knock-outs. Trim knock-out tabs (gates) that remain on the case. The top terminal block on the option card will need to be removed before completing step 6.
6. Slide the assembly back into the case. Be sure the rear cover latches engage in the case. If option card includes a top terminal block, install top terminal block at this time.

4.0 WIRING THE METER

WIRING OVERVIEW

Electrical connections are made via screw-clamp terminals located on the back of the meter. All conductors should conform to the meter's voltage and current ratings. All cabling should conform to appropriate standards of good installation, local codes and regulations. It is recommended that power supplied to the meter (DC or AC) be protected by a fuse or circuit breaker.

When wiring the meter, compare the numbers embossed on the back of the meter case against those shown in wiring drawings for proper wire position. Strip the wire, according to the terminal block specifications (stranded wires should be tinned with solder). Insert the lead into the correct terminal and then tighten the terminal until the wire is secure (Pull wire to verify tightness).

EMC INSTALLATION GUIDELINES

Although Red Lion Controls Products are designed with a high degree of immunity to Electromagnetic Interference (EMI), proper installation and wiring methods must be followed to ensure compatibility in each application. The type of the electrical noise, source or coupling method into a unit may be different for various installations. Cable length, routing, and shield termination are very important and can mean the difference between a successful or troublesome installation. Listed are some EMI guidelines for a successful installation in an industrial environment.

1. A unit should be mounted in a metal enclosure, which is properly connected to protective earth.
2. Use shielded cables for all Signal and Control inputs. The shield connection should be made as short as possible. The connection point for the shield depends somewhat upon the application. Listed below are the recommended methods of connecting the shield, in order of their effectiveness.
 - a. Connect the shield to earth ground (protective earth) at one end where the unit is mounted.
 - b. Connect the shield to earth ground at both ends of the cable, usually when the noise source frequency is over 1 MHz.
3. Never run Signal or Control cables in the same conduit or raceway with AC power lines, conductors, feeding motors, solenoids, SCR controls, and heaters, etc. The cables should be run through metal conduit that is properly grounded. This is especially useful in applications where cable runs are long and portable two-way radios are used in close proximity or if the installation

is near a commercial radio transmitter. Also, Signal or Control cables within an enclosure should be routed as far away as possible from contactors, control relays, transformers, and other noisy components.

4. Long cable runs are more susceptible to EMI pickup than short cable runs.
5. In extremely high EMI environments, the use of external EMI suppression devices such as Ferrite Suppression Cores for signal and control cables is effective. The following EMI suppression devices (or equivalent) are recommended:

Fair-Rite part number 0443167251 (RLC part number FCOR0000)

Line Filters for input power cables:

Schaffner # FN2010-1/07 (Red Lion Controls # LFIL0000)

6. To protect relay contacts that control inductive loads and to minimize radiated and conducted noise (EMI), some type of contact protection network is normally installed across the load, the contacts or both. The most effective location is across the load.
 - a. Using a snubber, which is a resistor-capacitor (RC) network or metal oxide varistor (MOV) across an AC inductive load is very effective at reducing EMI and increasing relay contact life.
 - b. If a DC inductive load (such as a DC relay coil) is controlled by a transistor switch, care must be taken not to exceed the breakdown voltage of the transistor when the load is switched. One of the most effective ways is to place a diode across the inductive load. Most RLC products with solid state outputs have internal zener diode protection. However external diode protection at the load is always a good design practice to limit EMI. Although the use of a snubber or varistor could be used.
RLC part numbers: Snubber: SNUB0000
Varistor: ILS11500 or ILS23000
7. Care should be taken when connecting input and output devices to the instrument. When a separate input and output common is provided, they should not be mixed. Therefore a sensor common should NOT be connected to an output common. This would cause EMI on the sensitive input common, which could affect the instrument's operation.

Visit RLC's web site at <http://www.redlion.net/emi> for more information on EMI guidelines, Safety and CE issues as they relate to Red Lion Controls products.

4.1 POWER WIRING

AC Power

Terminal 1: VAC
Terminal 2: VAC

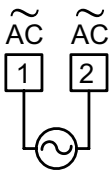

DC Power

Terminal 1: +VDC
Terminal 2: -VDC

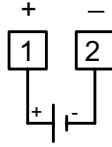

4.2 INPUT SIGNAL WIRING

Before connecting signal wires, the Input Range Jumper must be verified for proper position.

INPUT A SIGNAL WIRING

Voltage Signal (self powered)

Terminal 4: -VDC
Terminal 5: +VDC

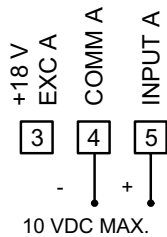

Current Signal (self powered)

Terminal 4: -ADC
Terminal 5: +ADC

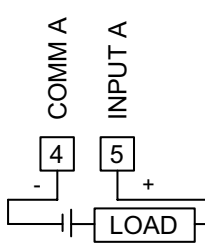

Current Signal (2 wire requiring excitation)

Terminal 3: +ADC
Terminal 5: -ADC

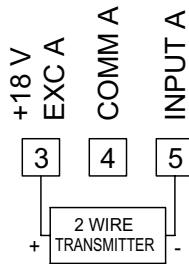

Voltage/Current Signal (3 wire requiring excitation)

Terminal 3: +VOLT supply
Terminal 4: -ADC (common)
Terminal 5: +ADC (signal)

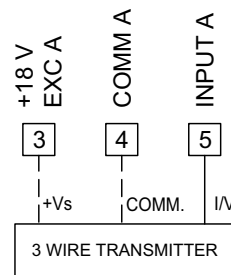

INPUT B SIGNAL WIRING

Voltage Signal (self powered)

Terminal 7: -VDC
Terminal 8: +VDC

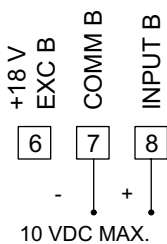

Current Signal (self powered)

Terminal 7: -ADC
Terminal 8: +ADC

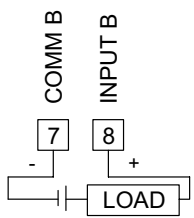

Current Signal (2 wire requiring excitation)

Terminal 6: +ADC
Terminal 8: -ADC

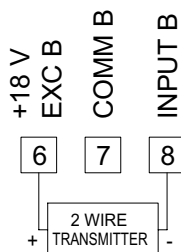

Voltage/Current Signal (3 wire requiring excitation)

Terminal 6: +VOLT supply
Terminal 7: -ADC (common)
Terminal 8: +ADC (signal)

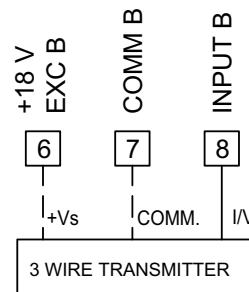

CAUTION: Sensor Input B common is NOT isolated from user input common. In order to preserve the safety of the meter application, the sensor input common must be suitably isolated from hazardous live earth referenced voltages; or input common must be at protective earth ground potential. If not, hazardous live voltage may be present at the User Inputs and User Input Common terminals. Appropriate considerations must then be given to the potential of the user input common with respect to earth common; and the common of the isolated option cards with respect to input common.

4.3 USER INPUT WIRING

Before connecting the wires, the User Input Logic Jumper should be verified for proper position. If not using User Inputs, then skip this section. Only the appropriate User Input terminal has to be wired.

Sinking Logic

Terminal 9: } Connect external switching device between
Terminal 10-11: } appropriate User Input terminal and User Comm.

In this logic, the user inputs of the meter are internally pulled up to +5 V with 22 K resistance. The input is active when it is pulled low (<0.9 V).

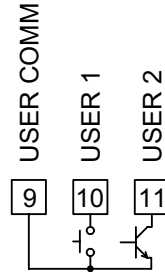

Sourcing Logic

Terminal 9: -VDC thru external switching device
Terminal 10-11: + VDC thru external switching device

In this logic, the user inputs of the meter are internally pulled down to 0 V with 22 K resistance. The input is active when a voltage greater than 3.6 VDC is applied.

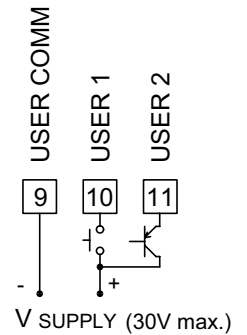

4.4 SETPOINT (ALARMS) WIRING

4.5 SERIAL COMMUNICATION WIRING

4.6 ANALOG OUTPUT WIRING

See appropriate option card bulletin for details.

5.0 REVIEWING THE FRONT BUTTONS AND DISPLAY

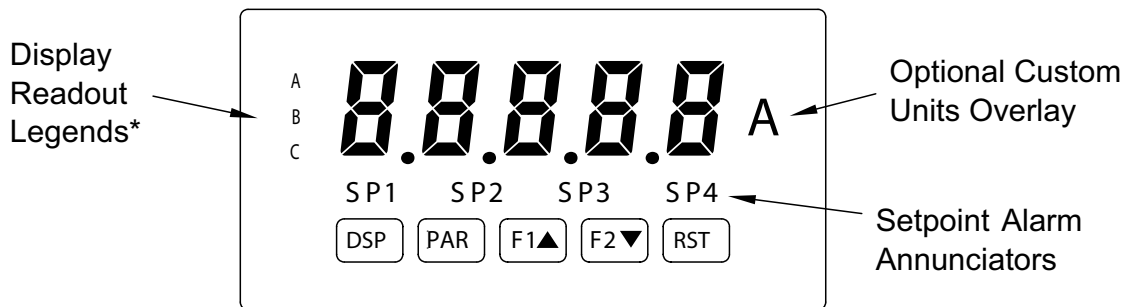

KEY DISPLAY MODE OPERATION

- DSP** Index display through main displays as programmed in 3-LDC
- PAR** Access parameter list
- F1▲** Function key 1; hold for 3 seconds for Second Function 1**
- F2▼** Function key 2; hold for 3 seconds for Second Function 2**
- RST** Reset (Function key)**

* Display Readout Legends may be locked out in Factory Settings.

** Factory setting for the F1, F2, and RST keys is NO mode.

PROGRAMMING MODE OPERATION

- Quit programming and return to display mode
- Store selected parameter and index to next parameter
- Increment selected parameter value
- Decrement selected parameter value
- Hold with F1▲, F2▼ to scroll value by x1000

6.0 PROGRAMMING THE METER

OVERVIEW

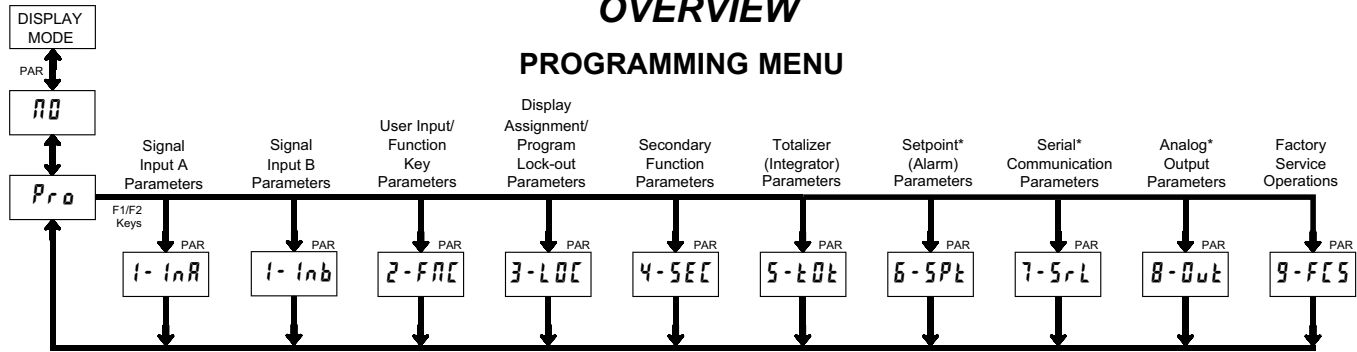

DISPLAY MODE

The meter normally operates in the Display Mode. In this mode, the meter displays can be viewed consecutively by pressing the **DSP** key. The annunciators to the left of the display indicate which display is currently shown; A, B, or C. Each of these displays are programmable and can be locked from view through programming. (See Module 3.)

PROGRAMMING MODE

Two programming modes are available.

Full Programming Mode permits all parameters to be viewed and modified.

Upon entering this mode, the front panel keys change to Programming Mode operations. This mode should not be entered while a process is running, since the meter functions and User Input response may not operate properly while in Full Programming Mode.

Quick Programming Mode permits only certain parameters to be viewed and/or modified. When viewing parameters (SPI, etc), the front panel keys change to Programming Mode operations, and all meter functions continue to operate properly. Quick Programming Mode is configured in Module 3. The Display Intensity Level “d-LEW” parameter is available in the Quick Programming Mode only when the security code is non-zero. For a description, see Module 9—Factory Service Operations. Throughout this document, Programming Mode (without Quick in front) always refers to “Full” Programming Mode.

PROGRAMMING TIPS

Programming the unit using Crimson programming software is recommended. The following tips are helpful when programming using the unit front panel keys. The Programming Menu is organized into ten modules (see above). These modules group together parameters that are related in function. It is recommended to begin programming with Module 1 and proceed through each module in sequence. Note that Modules 6 through 8 are only accessible when the appropriate option card is installed. If lost or confused while programming, press the **DSP** key to exit programming mode and start over. When programming is complete, it is recommended to record the meter settings on the Parameter Value Chart and lock-out parameter programming with a User Input or lock-out code. (See Modules 2 and 3 for lock-out details.)

FACTORY SETTINGS

Factory Settings may be completely restored in Module 9. This is a good starting point if encountering programming problems. Throughout the module description sections which follow, the factory setting for each parameter is shown below the parameter display. In addition, all factory settings are listed on the Parameter Value Chart following the programming section.

ALTERNATING SELECTION DISPLAY

In the module description sections which follow, the dual display with arrows appears for each programming parameter. This is used to illustrate the display alternating between the parameter (top display) and the parameter’s Factory Setting (bottom display). In most cases, selections or value ranges for the parameter will be listed on the right.

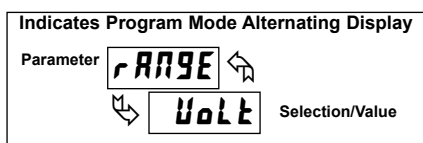

STEP BY STEP PROGRAMMING INSTRUCTIONS:

PROGRAMMING MODE ENTRY (PAR KEY)

The Programming Mode is entered by pressing the **PAR** key. If this mode is not accessible, then meter programming is locked by either a security code or a hardware lock. (See Modules 2 and 3 for programming lock-out details.)

MODULE ENTRY (ARROW & PAR KEYS)

Upon entering the Programming Mode, the display alternates between **Pr0** and the present module (initially **#0**). The arrow keys (**F1▲** and **F2▼**) are used to select the desired module, which is then entered by pressing the **PAR** key.

PARAMETER (MODULE) MENU (PAR KEY)

Each module has a separate parameter menu. These menus are shown at the start of each module description section which follows. The **PAR** key is pressed to advance to a particular parameter to be changed, without changing the programming of preceding parameters. After completing a module, the display will return to **Pr0 #0**. From this point, programming may continue by selecting and entering additional modules. (See **MODULE ENTRY** above.)

PARAMETER SELECTION ENTRY (ARROW & PAR KEYS)

For each parameter, the display alternates between the parameter and the present selection or value for that parameter. For parameters which have a list of selections, the arrow keys (**F1▲** and **F2▼**) are used to sequence through the list until the desired selection is displayed. Pressing the **PAR** key stores and activates the displayed selection, and also advances the meter to the next parameter.

NUMERICAL VALUE ENTRY (ARROW, RST & PAR KEYS)

For parameters which require a numerical value entry, the arrow keys can be used to increment or decrement the display to the desired value. When an arrow key is pressed and held, the display automatically scrolls up or down. The longer the key is held, the faster the display scrolls.

The **RST** key can be used in combination with the arrow keys to enter large numerical values. When the **RST** key is pressed along with an arrow key, the display scrolls by 1000’s. Pressing the **PAR** key stores and activates the displayed value, and also advances the meter to the next parameter.

PROGRAMMING MODE EXIT (DSP KEY or PAR KEY at Pr0 #0)

The Programming Mode is exited by pressing the **DSP** key (from anywhere in the Programming Mode) or the **PAR** key (with **Pr0 #0** displayed). This will commit any stored parameter changes to memory and return the meter to the Display Mode. If a parameter was just changed, the **PAR** key should be pressed to store the change before pressing the **DSP** key. (If power loss occurs before returning to the Display Mode, verify recent parameter changes.)

6.1 MODULE 1 - SIGNAL INPUT PARAMETERS

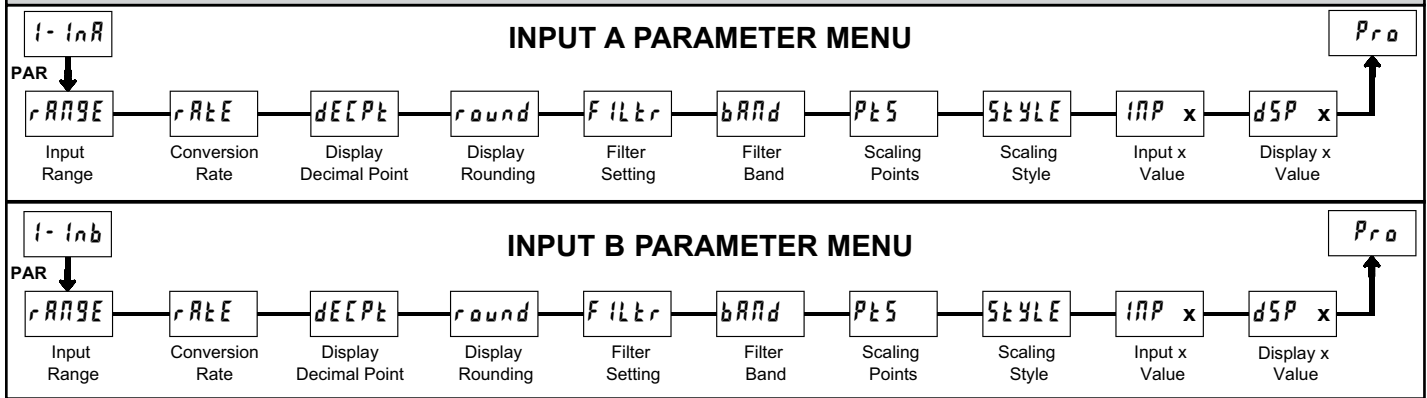

INPUT RANGE

SELECTION	RANGE	RESOLUTION
uolt	10.000 V	
curr	20.000 mA	
u-5qr	±10.000 V - Square Root Extraction	
i-5qr	±20.000 mA - Square Root Extraction	

Select the input range that corresponds to the external signal. Before applying signal configure input jumper to match setting desired.

ADC CONVERSION RATE

SELECTION	5.3	7.5	16.7	19.8
19.8	20	30	105	

Select the ADC conversion rate (conversions per second). The selection does not affect the display update rate, however it does affect setpoint and analog output response time. The default factory setting of 19.8 is recommended for most applications. Selecting a fast update rate may cause the display to appear very unstable.

DISPLAY DECIMAL POINT

SELECTION	0	00	000	0000	00000
0000					

Select the decimal point location for the Input display. (The **TOT** display decimal point is a separate parameter.) This selection also affects **round**, **dSP1** and **dSP2** parameters and setpoint values.

DISPLAY ROUNDING*

SELECTION	1	2	5	10
0001	20	50	100	

Rounding selections other than one, cause the Input Display to 'round' to the nearest rounding increment selected (ie. rounding of '5' causes 121 to round to 120 and 124 to round to 125). Rounding starts at the least significant digit of the Input Display. Remaining parameter entries (scaling point values, setpoint values, etc.) are not automatically adjusted to this display rounding selection.

FILTER SETTING

SELECTION	00 to 250
10	

The input filter setting is a time constant expressed in tenths of a second. The filter settles to 99% of the final display value within approximately 3 time constants. This is an Adaptive Digital Filter which is designed to steady the Input Display reading. A value of '0' disables filtering.

FILTER BAND*

SELECTION	0 to 250
0010	

The digital filter will adapt to variations in the input signal. When the variation exceeds the input filter band value, the digital filter disengages. When the variation becomes less than the band value, the filter engages again. This allows for a stable readout, but permits the display to settle rapidly after a large process change. The value of the band is in display units, independent of the Display Decimal Point position. A band setting of '0' keeps the digital filter permanently engaged.

SCALING POINTS

SELECTION	2 to 16
2	

Linear - Scaling Points (2)

For linear processes, only 2 scaling points are necessary. It is recommended that the 2 scaling points be at opposite ends of the input signal being applied. The points do not have to be the signal limits. Display scaling will be linear between and continue past the entered points up to the limits of the Input Signal Jumper position. Each scaling point has a coordinate-pair of Input Value (**INP**) and an associated desired Display Value (**dSP**).

Square Root Extraction Input Range - Scaling Points (2)

The PAXDP can apply the square root function directly to the sensor signal by selecting the Square Root Extraction Input Range (**u-5qr** or **i-5qr**). When configured for Square Root Extraction, piecewise multipoint linearization is not required and only the first 2 scaling points are used. For proper operation the Display 1 (**dSP1**) value must be zero.

Nonlinear - Scaling Points (Greater than 2)

For non-linear processes, up to 16 scaling points may be used to provide a piece-wise linear approximation. (The greater the number of scaling points used, the greater the conformity accuracy.) The Input Display will be linear between scaling points that are sequential in program order. Each scaling point has a coordinate-pair of Input Value (**INP**) and an associated desired Display Value (**dSP**). Data from tables or equations, or empirical data could be used to derive the required number of segments and data values for the coordinate pairs.

In the Crimson 2 (SFCRM2) software, several linearization equations are available. See the Accessories section for more information.

SCALING STYLE

SELECTION	KEY	key-in data
KEY	RPLY	apply signal

If Input Values and corresponding Display Values are known, the Key-in (**KEY**) scaling style can be used. This allows scaling without the presence or changing of the input signal. If Input Values have to be derived from the actual input signal source or simulator, the Apply (**RPLY**) scaling style must be used.

* The decimal point position is dependent on the selection made in the "Display Decimal Point" parameter.

INPUT VALUE FOR SCALING POINT 1

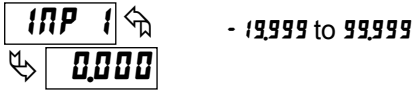

For Key-in (**KEY**), enter the known first Input Value by using the arrow keys. (The Input Range selection sets up the decimal location for the Input Value.) For Apply (**APLY**), apply the input signal to the meter, adjust the signal source externally until the desired Input Value appears. In either method, press the **PAR** key to enter the value being displayed. In the **APLY** style, the **RST** key can be pressed to advance the display past the **INP 1** value or other input value without storing it. This is useful for application scaling of the second scaling point (i.e. when the tank is full), or some other point in multipoint applications.

DISPLAY VALUE FOR SCALING POINT 1*

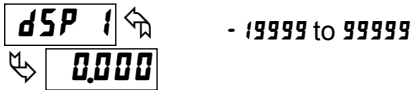

Enter the first coordinating Display Value by using the arrow keys. This is the same for **KEY** and **APLY** scaling styles. The decimal point follows the **DECLPT** selection. For Square Root Extraction Input Range, the Display 1 value must be zero.

INPUT VALUE FOR SCALING POINT 2

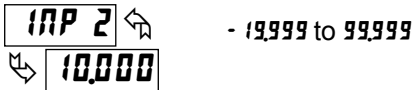

For Key-in (**KEY**), enter the known second Input Value by using the arrow keys. For Apply (**APLY**), adjust the signal source externally until the next desired Input Value appears. (Follow the same procedure if using more than 2 scaling points.)

* The decimal point position is dependent on the selection made in the "Display Decimal Point" parameter.

DISPLAY VALUE FOR SCALING POINT 2*

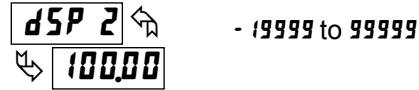

Enter the second coordinating Display Value by using the arrow keys. This is the same for **KEY** and **APLY** scaling styles. (Follow the same procedure if using more than 2 scaling points.)

General Notes on Scaling

1. Input Values for scaling points should be confined to the limits of the Input Signal, i.e. 4-20 mA or 0-10 VDC.
2. The same Input Value should not correspond to more than one Display Value. (Example: 20 mA can not equal 0 and 10.) This is referred to as readout jumps (vertical scaled segments).
3. The same Display Value can correspond to more than one Input Value. (Example: 0 mA and 20 mA can equal 10.) This is referred to as readout dead zones (horizontal scaled segments).
4. The maximum scaled Display Value spread between range maximum and minimum is limited to 65,535. For example using +20 mA range the maximum +20 mA can be scaled to is 32,767 with 0 mA being 0 and Display Rounding of 1. (Decimal points are ignored.) The other half of 65,535 is for the lower half of the range 0 to -20 mA even if it is not used. With Display Rounding of 2, +20 mA can be scaled for 65,535 (32,767 x 2) but with even Input Display values shown.
5. For input levels beyond the first programmed Input Value, the meter extends the Display Value by calculating the slope from the first two coordinate pairs (**INP 1 / dSP 1** & **INP 2 / dSP 2**). If **INP 1** = 4 mA and **dSP 1** = 0, then 0 mA would be some negative Display Value. This could be prevented by making **INP 1** = 0 mA / **dSP 1** = 0, **INP 2** = 4 mA / **dSP 2** = 0, with **INP 3** = 20 mA / **dSP 3** = the desired high Display Value. The calculations stop at the limits of the Input Range Jumper position.
6. For input levels beyond the last programmed Input Value, the meter extends the Display Value by calculating the slope from the last two sequential coordinate pairs. If three coordinate pair scaling points were entered, then the Display Value calculation would be between **INP 2 / dSP 2** & **INP 3 / dSP 3**. The calculations stop at the limits of the Signal Input.

6.2 MODULE 2 - USER INPUT AND FRONT PANEL FUNCTION KEY PARAMETERS (2-FNC)

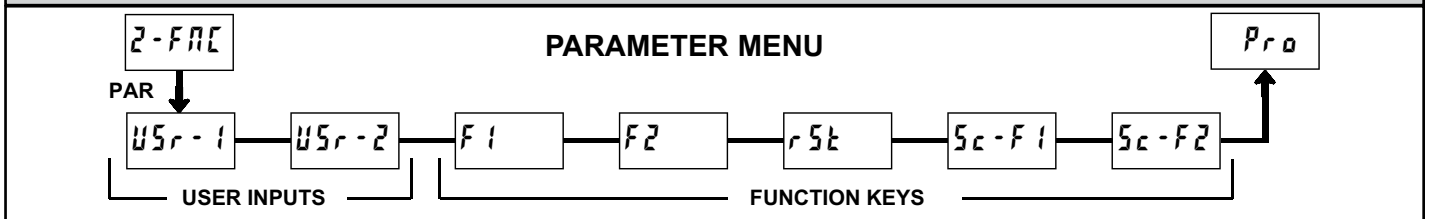

The two user inputs are individually programmable to perform specific meter control functions. While in the Display Mode or Program Mode, the function is executed the instant the user input transitions to the active state.

The front panel function keys are also individually programmable to perform specific meter control functions. While in the Display Mode or when viewing meter values in Quick Programming mode, the primary function is executed the instant the key is pressed. Holding the function key for three seconds executes a secondary function. It is possible to program a secondary function without a primary function.

In most cases, if more than one user input and/or function key is programmed for the same function, the maintained (level trigger) actions will be performed while at least one of those user inputs or function keys are activated. The momentary (edge trigger) actions will be performed every time any of those user inputs or function keys transition to the active state.

Note: In the following explanations, not all selections are available for both user inputs and front panel function keys. Alternating displays are shown with each selection. Those selections showing both displays are available for both. If a display is not shown, it is not available for that selection. **USr-1** will represent both user inputs. **F1** will represent all five function keys.

NO FUNCTION



No function is performed if activated. This is the factory setting for all user inputs and function keys. No function can be selected without affecting basic start-up.

PROGRAMMING MODE LOCK-OUT

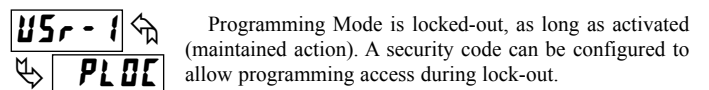

Programming Mode is locked-out, as long as activated (maintained action). A security code can be configured to allow programming access during lock-out.

INPUT A ZERO (TARE) DISPLAY



The Zero (Tare) Display provides a way to zero the Input A value at various input levels, causing future Display readings to be offset. This function is useful in weighing applications where the container or material on the scale should not be included in the next measurement value. When activated (momentary action), **rESEt** flashes and the Input A value is set to zero. At the same time, the Input A value (that was on the display before the Zero Display) is subtracted from the Input A Display Offset Value and is automatically stored as the new Display Offset Value (**BF5-A**). If another Zero (tare) Display is performed, the display will again change to zero and the Input A reading will shift accordingly.

INPUT B ZERO (TARE) DISPLAY



The Zero (Tare) Display provides a way to zero the Input B value at various input levels, causing future Display readings to be offset. This function is useful in weighing applications where the container or material on the scale should not be included in the next measurement value. When activated (momentary action), **rESEt** flashes and the Input B value is set to zero. At the same time, the Input B value (that was on the display before the Zero Display) is subtracted from the Input B Display Offset Value and is automatically stored as the new Display Offset Value (**BF5-b**). If another Zero (tare) Display is performed, the display will again change to zero and the Input B reading will shift accordingly.

INPUT A RELATIVE/ABSOLUTE DISPLAY



This function will switch the Input A Display between Relative and Absolute. The Relative is a net value that includes the Display Offset Value. The Input A Display will normally show the Relative unless switched by this function. The Absolute is a gross value (based on Module 1 **DSP** and **INP** entries) without the Display Offset Value. The Absolute display is selected as long as the user input is activated (maintained action) or at the transition of the function key (momentary action). When the user input is released, or the function key is pressed again, the input A display switches back to Relative display. **Ab5-A** (absolute) or **rEL-A** (relative) is momentarily displayed at transition to indicate which display is active.

INPUT B RELATIVE/ABSOLUTE DISPLAY



This function will switch the Input B Display between Relative and Absolute. The Relative is a net value that includes the Display Offset Value. The Input B Display will normally show the Relative unless switched by this function. The Absolute is a gross value (based on Module 1 **DSP** and **INP** entries) without the Display Offset Value. The Absolute display is selected as long as the user input is activated (maintained action) or at the transition of the function key (momentary action). When the user input is released, or the function key is pressed again, the input B display switches back to Relative display. **Ab5-A** (absolute) or **rEL-A** (relative) is momentarily displayed at transition to indicate which display is active.

HOLD DISPLAY

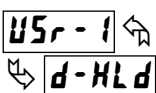

The shown display is held but all other meter functions continue as long as activated (maintained action).

HOLD ALL FUNCTIONS

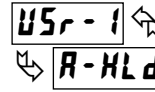

The meter disables processing the input, holds all display contents, and locks the state of all outputs as long as activated (maintained action). The serial port continues data transfer.

SYNCHRONIZE METER READING

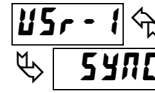

The meter suspends all functions as long as activated (maintained action). When the user input is released, the meter synchronizes the restart of the A/D's with other processes or timing events.

Input assignment for the totalizer is programmed in Module 5, Totalizer (Integrator) Parameters. Only the assigned input or calculation will be active for the following Totalizer User Functions.

STORE BATCH READING IN TOTALIZER



The assigned value is one time added (batched) to the Totalizer at transition to activate (momentary action). The Totalizer retains a running sum of each batch operation until the Totalizer is reset. When this function is selected, the normal operation of the Totalizer is overridden.

RESET TOTALIZER



When activated (momentary action), **rESEt** flashes and the Totalizer resets to zero. The Totalizer then continues to operate as it is configured. This selection functions independent of the selected display.

RESET AND ENABLE TOTALIZER

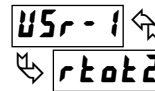

When activated (momentary action), **rESEt** flashes and the Totalizer resets to zero. The Totalizer continues to operate while active (maintained action). When the user input is released, the Totalizer stops and holds its value. This selection functions independent of the selected display.

ENABLE TOTALIZER

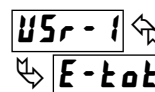

The Totalizer continues to operate as long as activated (maintained action). When the user input is released, the Totalizer stops and holds its value. This selection functions independent of the selected display.

RESET MAXIMUM



When activated (momentary action), **rESEt** flashes and the Maximum resets to the present assigned value. The Maximum function then continues from that value. This selection functions independent of the selected display.

RESET MINIMUM

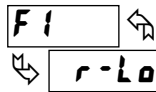
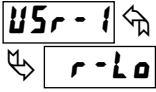

When activated (momentary action), **rESEt** flashes and the Minimum reading is set to the present assigned value. The Minimum function then continues from that value. This selection functions independent of the selected display.

CHANGE DISPLAY INTENSITY LEVEL

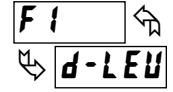
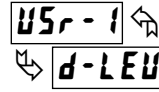

When activated (momentary action), the display intensity changes to the next intensity level (of 4). The four levels correspond to Display Intensity Level (**d-LEU**) settings of 0, 3, 8, and 15.

RESET MAXIMUM AND MINIMUM

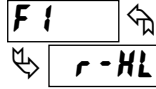
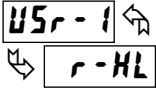

When activated (momentary action), **rESEt** flashes and the Maximum and Minimum readings are set to the present assigned values. The Maximum and Minimum function then continues from that value. This selection functions independent of the selected display.

SETPOINT SELECTIONS

The following selections are functional only with the Setpoint option card installed. Refer to Module 6 - Setpoint (Alarm) Parameters for an explanation of their operation.

Setpoint Card Only	}	L15t - Select main or alternate setpoints
		r-1 - Reset Setpoint 1 (Alarm 1)
		r-2 - Reset Setpoint 2 (Alarm 2)
		r-3 - Reset Setpoint 3 (Alarm 3)
		r-4 - Reset Setpoint 4 (Alarm 4)
		r-34 - Reset Setpoint 3 & 4 (Alarm 3 & 4)
		r-234 - Reset Setpoint 2, 3 & 4 (Alarm 2, 3 & 4)
r-ALL - Reset Setpoint All (Alarm All)		

Note: Following display functions are only available on User Input.

ADVANCE DISPLAY

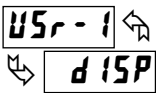

When activated (momentary action), the display advances to the next display that is not locked out from the Display Mode.

SELECT DISPLAY A

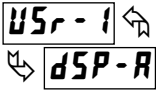

When activated (momentary action), the display advances to Display A, if enabled.

SELECT DISPLAY B

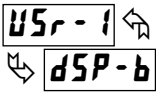

When activated (momentary action), the display advances to Display B, if enabled.

SELECT DISPLAY C

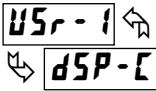

When activated (momentary action), the display advances to Display C, if enabled.

SELECT DISPLAY _

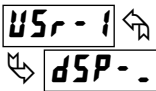

When activated (momentary action), the display advances to the Display _ (no annunciator), if enabled.

SELECT SETPOINT LIST

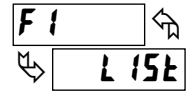
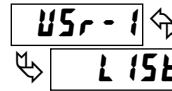

Two lists of values are available for **SP-1**, **SP-2**, **SP-3**, **SP-4**. The two lists are named **L5t-A** and **L5t-b**. If a user input is used to select the list then **L5t-A** is selected when the user input is not active and **L5t-b** is selected when the user input is active (maintained action). If a front panel key is used to select the list then the list will toggle for each key press (momentary action). The display will only indicate which list is active when the list is changed.

To program the values for **L5t-A** and **L5t-b**, first complete the programming of all the parameters. Exit programming and switch to the other list. Re-enter programming and enter the values for **SP-1**, **SP-2**, **SP-3**, **SP-4**. If any other parameters are changed then the other list values must be reprogrammed.

PRINT REQUEST

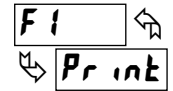
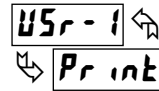

The meter issues a block print through the serial port when activated, and the serial type is set to **rLC**. The data transmitted during a print request and the serial type is programmed in Module 7. If the user input is still active after the transmission is complete (about 100 msec), an additional transmission occurs. As long as the user input is held active, continuous transmissions occur.

6.3 MODULE 3 - DISPLAY ASSIGNMENT AND PROGRAM LOCK-OUT PARAMETERS (3-LOC)

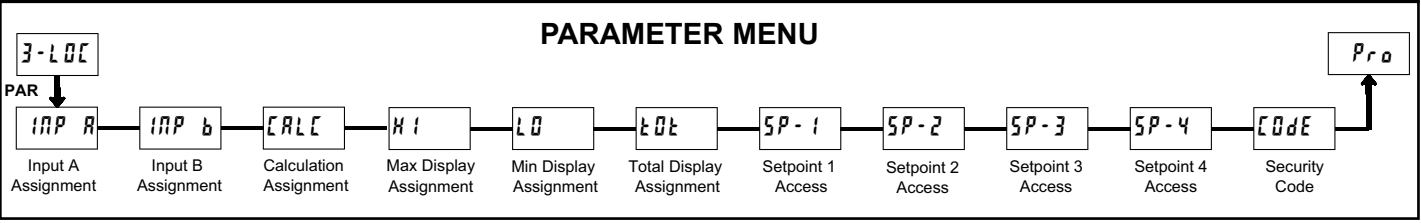

Module 3 is the programming for the Display, Display assignments, Display lock-out and “Full” and “Quick” Program lock-out.

When in the main Display Mode, the available displays (A,B,C,_) can be read consecutively by repeatedly pressing the **DSP** key. An annunciator indicates the display being shown (_ = No annunciator). A meter display value can be programmed to one of the displays, to the quick programming mode or be locked from being visible. It is recommended that the meter display value be set to **LOC** when it is not being used in the application.

“Full” Programming Mode permits all parameters to be viewed and modified. This Programming Mode can be locked with a security code and/or user input. When locked and the PAR key is pressed, the meter enters a Quick Programming Mode. In this mode, the setpoint values can still be read and/or changed per the selections below. The display Intensity Level (**d-LEH**) parameter also appears whenever Quick Programming Mode is enabled and the security code greater than zero.

SP-1 SP-2 SP-3 SP-4 SETPOINT ACCESS*

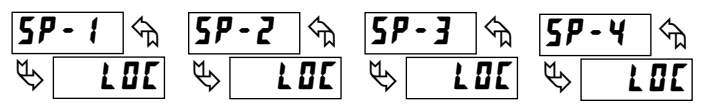

The setpoint displays can be programmed for **LOC**, **rEd** or **ENt** (see the following table). Accessible only with the Setpoint option card installed.

SELECTION	DESCRIPTION
LOC	Not visible in Quick Programming Mode Only
rEd	Visible in Quick Programming Mode Only
ENt	Visible and changeable in Quick Programming Mode Only

DISPLAY ASSIGNMENT

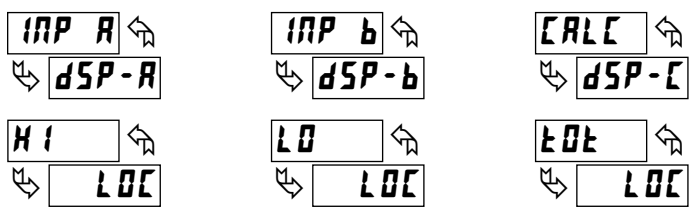

There are six meter values that can be individually programmed for one of the main displays (A,B,C or _), or programmed to be viewable in Quick Programming mode (rEd), or programmed to be locked out from display (LOC) (see the following table). If two or more values are assigned to the same display the last value assigned will be the one that is displayed.

LOC	Not visible in Display Mode or Quick Programming Mode
rEd	Visible in Quick Programming Mode only
dSP- _	Assign to Display _ (No annunciator)
dSP-A	Assign to Display A
dSP-b	Assign to Display B
dSP-C	Assign to Display C

PROGRAM MODE SECURITY CODE*

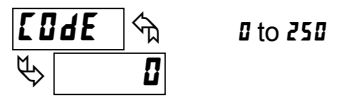

By entering any non-zero value, the prompt **CODE 0** will appear when trying to access the Program Mode. Access will only be allowed after entering a matching security code. With this lock-out, a user input would not have to be configured for Program Lock-out. However, this lock-out is overridden by an inactive user input configured for Program Lock-out.

* Factory Setting can be used without affecting basic start-up.

PROGRAMMING MODE ACCESS

SECURITY CODE	USER INPUT CONFIGURED	USER INPUT STATE	WHEN PAR KEY IS PRESSED	“FULL” PROGRAMMING MODE ACCESS
0	not PLOC	_____	“Full” Programming	Immediate access.
>0	not PLOC	_____	Quick Programming w/Display Intensity	After Quick Programming with correct code # at CODE prompt.
>0	PLOC	Active	Quick Programming w/Display Intensity	After Quick Programming with correct code # at CODE prompt.
>0	PLOC	Not Active	“Full” Programming	Immediate access.
0	PLOC	Active	Quick Programming	No access
0	PLOC	Not Active	“Full” Programming	Immediate access.

Throughout this document, Programming Mode (without Quick in front) always refers to “Full” Programming (all meter parameters are accessible).

6.4 MODULE 4 - SECONDARY FUNCTION PARAMETERS (4-5EE)

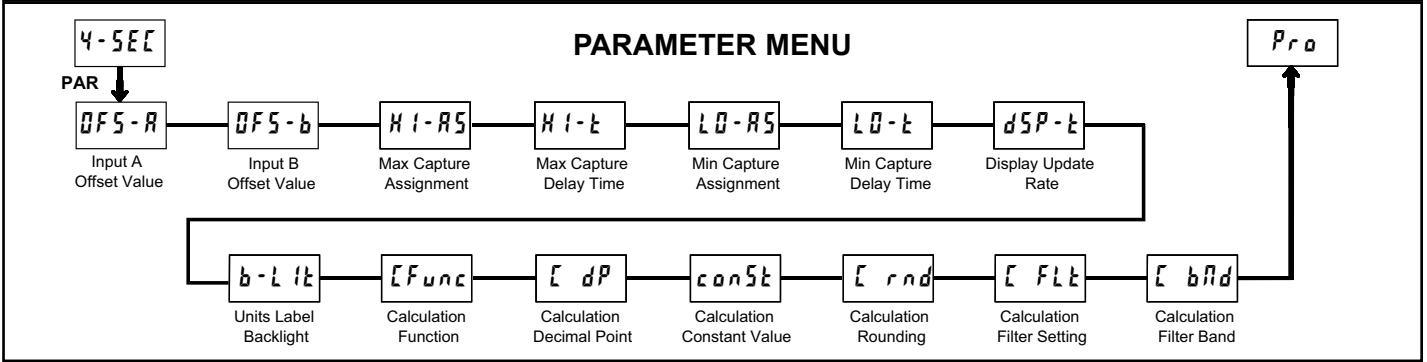

INPUT A OFFSET VALUE*

OFS-A ←
← **0.000**

- 19999 to 19999

Unless a Zero Display was performed or an offset from Module 1 scaling is desired for Input A, this parameter can be skipped. The Display Offset Value is the difference between the Absolute (gross) Display value and the Relative (net) Display value for the same input level. The meter will automatically update this Display Offset Value after each Zero Display. The Display Offset Value can be directly keyed-in to intentionally add or remove display offset. See Relative / Absolute Display and Zero Display explanations in Module 2.

INPUT B OFFSET VALUE*

OFS-b ←
← **0.000**

- 19999 to 19999

Unless a Zero Display was performed or an offset from Module 1 scaling is desired for Input B, this parameter can be skipped. The Display Offset Value is the difference between the Absolute (gross) Display value and the Relative (net) Display value for the same input level. The meter will automatically update this Display Offset Value after each Zero Display. The Display Offset Value can be directly keyed-in to intentionally add or remove display offset. See Relative / Absolute Display and Zero Display explanations in Module 2.

MAX CAPTURE ASSIGNMENT

HI-RS ←
← **A-rEL**

A-rEL A-RbS b-rEL b-RbS [RLC]

Select the desired parameter that will be assigned to the Max Capture.

MAX CAPTURE DELAY TIME

HI-t ←
← **10**

00 to 32750 sec.

When the Input Display is above the present MAX value for the entered delay time, the meter will capture that display value as the new MAX reading. A delay time helps to avoid false captures of sudden short spikes.

MIN CAPTURE ASSIGNMENT

LO-RS ←
← **A-rEL**

A-rEL A-RbS b-rEL b-RbS [RLC]

Select the desired parameter that will be assigned to the Min Capture.

MIN CAPTURE DELAY TIME

LO-t ←
← **10**

00 to 32750 sec.

When the Input Display is below the present MIN value for the entered delay time, the meter will capture that display value as the new MIN reading. A delay time helps to avoid false captures of sudden short spikes.

DISPLAY UPDATE RATE

dSP-t ←
← **1**

1 2 5 10 20 updates/sec.

This parameter determines the rate of display update.

UNITS LABEL BACKLIGHT

b-Lit ←
← **OFF**

ON OFF

The Units Label Kit Accessory contains a sheet of custom unit overlays which can be installed in to the meter's bezel display assembly. The backlight for these custom units is activated by this parameter.

CALCULATION FUNCTION

CFunc ←
← **c+A+b**

c+A+b c-A-b cA/b c-A-b Ab/c c(A/b-1)

This parameter determines the math calculation that will be performed on Input A and Input B and shown on the calculation display. The above formulas represent the available calculations; **A** = Input A relative value, **b** = Input B relative value, and **c** = Calculation Constant Value (**const**). For the average between A and B inputs, scale the display (Input A & Input B **dSP** x) values in half and then use **C+A+B**.

Note: **+** = add, **-** = subtract, **/** = division, **c(A/b-1)** is displayed in the PAX as **Ab/c-1** and the function performs with A divided b then 1 is subtracted and the result is multiply by c.

CALCULATION DECIMAL POINT

cDP ←
← **0.000**

0 00 000 0000 00000

This parameter determines the decimal point location for the Calculation Display. For the **c+A+b**, **c-A-b**, and **c+A-b** calculation functions, Input A "Display Decimal Point", Input B "Display Decimal Point" and "Calculation Decimal Point" must all be in the same position.

* The decimal point position is dependent on the selection made in the "Display Decimal Point" parameter.

CALCULATION CONSTANT VALUE

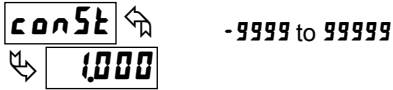

The constant value is used in the Calculation Function formulas to provide offsetting or scaling capabilities. For the $\int A-b$, $\int -A-b$, and $\int A-b$ calculation functions, the Constant decimal point matches that Calculation Decimal point position. For these functions, the “Constant Value” must be lowered to a value of 0 for no offset.

For the $A/b/c$, cA/b , and $c(A/b - 1)$ calculation functions, there is no “Constant Value” decimal point shown. However, when Input A “Display Decimal Point”, Input B “Display Decimal Point” and “Calculation Decimal Point” are in the same position, then the “Constant Value” decimal point will be assumed to be at the same location as the “Calculation Decimal Point”. For the Calculation Display to have the same resolution as Inputs A & B, the “Constant Value” must be a value of 1 with trailing 0's for each assumed decimal point location. Example: With Input A, Input B and the Calculation decimal points entered as 0.00, then the “Constant Value” would be entered as 100 for no gain.

CALCULATION ROUNDING*

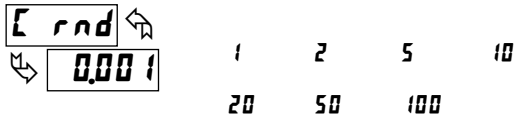

Rounding selections other than one, cause the Calculation Display to ‘round’ to the nearest rounding increment selected (ie. rounding of ‘0.005’ causes 0.121 to round to 0.120 and 0.124 to round to 125). Rounding starts at the least significant digit of the Calculation Display. Remaining parameter entries (scaling point values, setpoint values, etc.) are not automatically adjusted to this display rounding selection. The displayed decimal point reflects that programmed in $\int dp$.

CALCULATION FILTER SETTING



The calculation filter setting is a time constant expressed in tenths of a second. The filter settles to 99% of the final display value within approximately 3 time constants. This is an Adaptive Digital Filter which is designed to steady the Calculation Display reading. A value of ‘0’ disables filtering.

CALCULATION FILTER BAND*

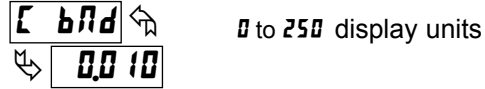

The digital filter will adapt to variations in the calculation filter. When the variation exceeds the calculation filter band value, the digital filter disengages. When the variation becomes less than the band value, the filter engages again. This allows for a stable readout, but permits the display to settle rapidly after a large process change. The value of the band is in display units, independent of the Display Decimal Point position. A band setting of ‘0’ keeps the digital filter permanently engaged.

* The decimal point position is dependent on the selection made in the “Display Decimal Point” parameter.

6.5 MODULE 5 - TOTALIZER (INTEGRATOR) PARAMETERS (5-101)

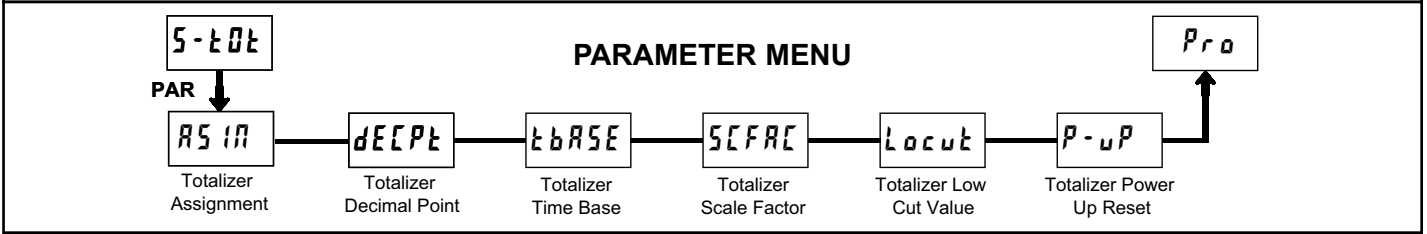

The totalizer accumulates (integrates) the relative Input value using one of two modes. The first is using a time base. This can be used to provide an indication of total flow, usage or consumption over time. The second is through a user input or function key programmed for Batch (one time add on demand). This can be used for weighing applications where accumulation is based on a completed event. If the Totalizer is not needed, its display can be locked-out and this module can be skipped during programming.

TOTALIZER ASSIGNMENT



This parameter determines which value is to be totalized.

TOTALIZER DECIMAL POINT*



For most applications, this should match the decimal point position of the meter value selected in the totalizer assignment. If a different location is desired, refer to Totalizer Scale Factor.

TOTALIZER TIME BASE

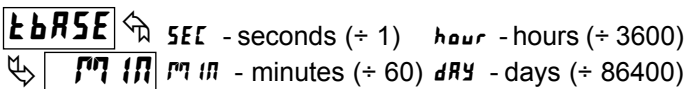

This is the time base used in Totalizer accumulations. If the Totalizer is being accumulated through a user input programmed for Batch, then this parameter does not apply.

TOTALIZER SCALE FACTOR*



For most applications, the Totalizer reflects the same decimal point location and engineering units as the assigned Input Display. In these cases, the Totalizer Scale Factor is 1.000. The Totalizer Scale Factor can be used to scale the Totalizer to a different value than the Input Display. Common possibilities are:

1. Changing decimal point location (example tenths to whole)
 2. Average over a controlled time frame.
- Details on calculating the scale factor are shown later.

If the Totalizer is being accumulated through a user input programmed for Batch, then this parameter does not apply.

TOTALIZER LOW CUT VALUE*

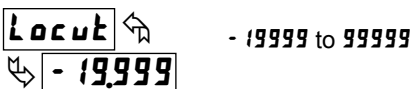

A low cut value disables Totalizer when the Input Display value falls below the value programmed.

* The decimal point position is dependent on the selection made in the "Totalizer Decimal Point" parameter.

TOTALIZER POWER UP RESET

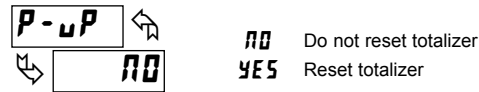

The Totalizer can be reset to zero on each meter power-up by setting this parameter to reset.

TOTALIZER HIGH ORDER DISPLAY

When the total exceeds 5 digits, the front panel annunciator flashes (if assigned to A, B, or C display). In this case, the meter continues to totalize up to a 9 digit value. The high order 4 digits and the low order 5 digits of the total are displayed alternately. The letter "h" denotes the high order display.

TOTALIZER BATCHING

The Totalizer Time Base and scale factor are overridden when a user input or function key is programmed for store batch (bAt). In this mode, when the user input or function key is activated, the Input Display reading is one time added to the Totalizer (batch). The Totalizer retains a running sum of each batch operation until the Totalizer is reset. This is useful in weighing operations, when the value to be added is not based on time but after a filling event.

TOTALIZER USING TIME BASE

Totalizer accumulates as defined by:

$$\frac{\text{Input Display} \times \text{Totalizer Scale Factor}}{\text{Totalizer Time Base}}$$

Where:

- Input Display - the present input reading
- Totalizer Scale Factor - 0.001 to 65.000
- Totalizer Time Base - (the division factor of tBASE)

Example: The input reading is at a constant rate of 10.0 gallons per minute. The Totalizer is used to determine how many gallons in tenths has flowed. Because the Input Display and Totalizer are both in tenths of gallons, the Totalizer Scale Factor is 1. With gallons per minute, the Totalizer Time Base is minutes (60). By placing these values in the equation, the Totalizer will accumulate every second as follows:

$$\frac{10.0 \times 1.000}{60} = 0.1667 \text{ gallons accumulate each second}$$

This results in:
10.0 gallons accumulate each minute
600.0 gallons accumulate each hour

TOTALIZER SCALE FACTOR CALCULATION EXAMPLES

1. When changing the Totalizer Decimal Point (dECPt) location from the Input Display Decimal Point (dECPt), the required Totalizer Scale Factor is multiplied by a power of ten.

Example: Input (dECPt) = 0.0 Input (dECPt) = 0.00

Totalizer dECPt	Scale Factor	Totalizer dECPt	Scale Factor
0.00	10	0.000	10
0.0	1	0.00	1
0	.1	0.0	.1
x10	.01	0	.01
x100	.001	x10	.001

(x = Totalizer display is round by tens or hundreds)

2. To obtain an average reading within a controlled time frame, the selected Totalizer Time Base is divided by the given time period expressed in the same timing units.

Example: Average flow rate per hour in a 4 hour period, the scale factor would be 0.250. To achieve a controlled time frame, connect an external timer to a user input programmed for rAt. The timer will control the start (reset) and the stopping (hold) of the totalizer.

6.6 MODULE 6 - SETPOINT (ALARM) PARAMETERS (δ-SPt) ▽

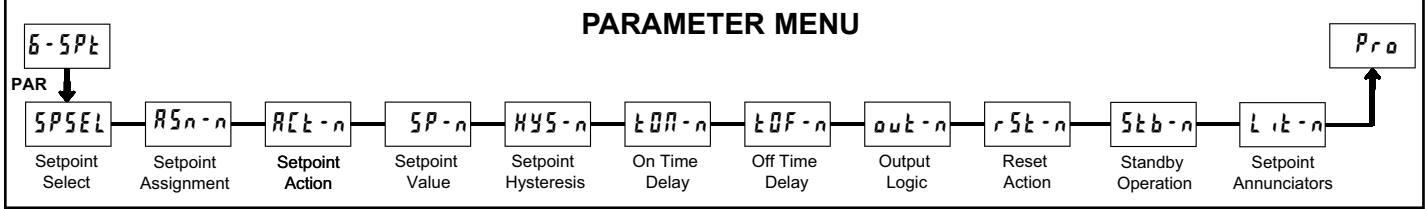

▽ - A setpoint card must be installed in order to access this module.

Repeat programming for each setpoint.

SELECT SETPOINT

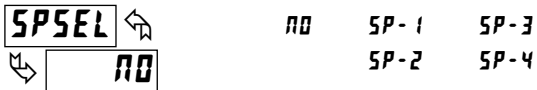

Select a setpoint (alarm output) to open the remaining module menu. (The “n” in the following parameters will reflect the chosen setpoint number.) After the chosen setpoint is programmed, the display will default to **SPSEL NO**. Select the next setpoint to be programmed and continue the sequence for each setpoint. Pressing **PAR** at **SPSEL NO** will exit Module 6.

SETPOINT ASSIGNMENT

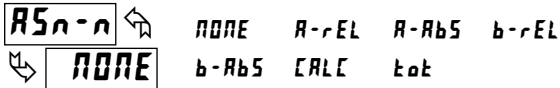

Selects the meter value that is used to trigger the Setpoint Alarm. The **-rEL** settings cause the setpoint to trigger off of the relative (net) input value. The relative input value is the absolute input value that includes the Display Offset Value. The **-Rb5** settings cause the setpoint to trigger off of the absolute (gross) input value. The absolute input value is based on Module 1 **dSP** and **INP** entries.

SETPOINT ACTION

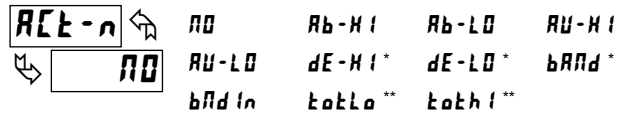

Enter the action for the selected setpoint (alarm output).

See the Setpoint Alarm Figures in the Setpoint Card Bulletin for a visual detail of each action. The Inside Band action is shown here as it only applies to the PAXDP.

- NO** = No Setpoint Action
- Ab-HI** = Absolute high, with balanced hysteresis
- Ab-LO** = Absolute low, with balanced hysteresis
- AU-HI** = Absolute high, with unbalanced hysteresis
- AU-LO** = Absolute low, with unbalanced hysteresis
- dE-HI** = Deviation high, with unbalanced hysteresis *
- dE-LO** = Deviation low, with unbalanced hysteresis *
- bAND** = Outside band, with unbalanced hysteresis *
- bNdIn** = Inside band, with unbalanced hysteresis *
- taktLo** = Lower Totalizer absolute high, unbalance hysteresis **
- taktHi** = Upper Totalizer absolute high, unbalance hysteresis **

* Setpoint 2 or Setpoint 4 deviation and band action setpoints are relative to the value of setpoint 1 or Setpoint 3 respectively. It is not possible to configure setpoint 1 or 3 as deviation or band actions. It is possible to use setpoint 1 or 3 for an absolute action, while its value is being used for deviation or band.

** These modes only appear, and are the only modes that appear, when the setpoint assignment **RSn-n** is set to **takt**. The lower Totalizer action, **taktLo**, allows setpoints to function off of the lower 5 digits of the Totalizer. The upper Totalizer action, **taktHi**, allows setpoints to function off of the upper 4 digits of the Totalizer. To obtain absolute low alarms for the Totalizer, program the **taktLo** or **taktHi** output logic as reverse.

Setpoint Alarm Figures

With reverse output logic **rELu**, the below alarm states are opposite.

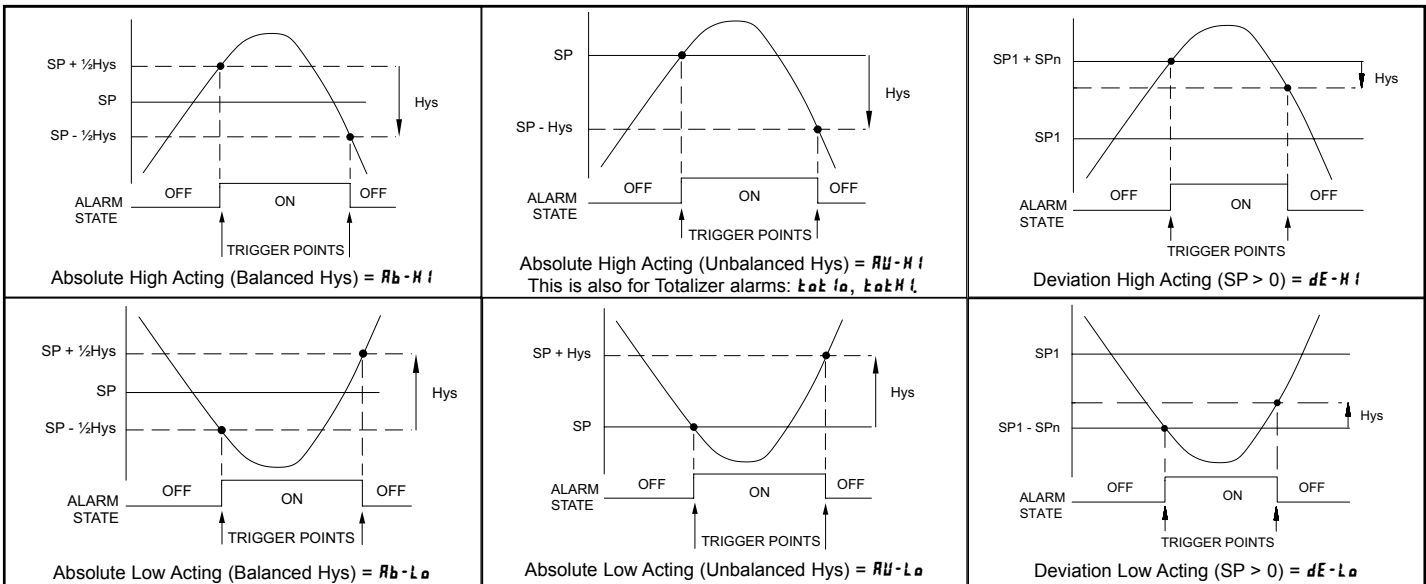

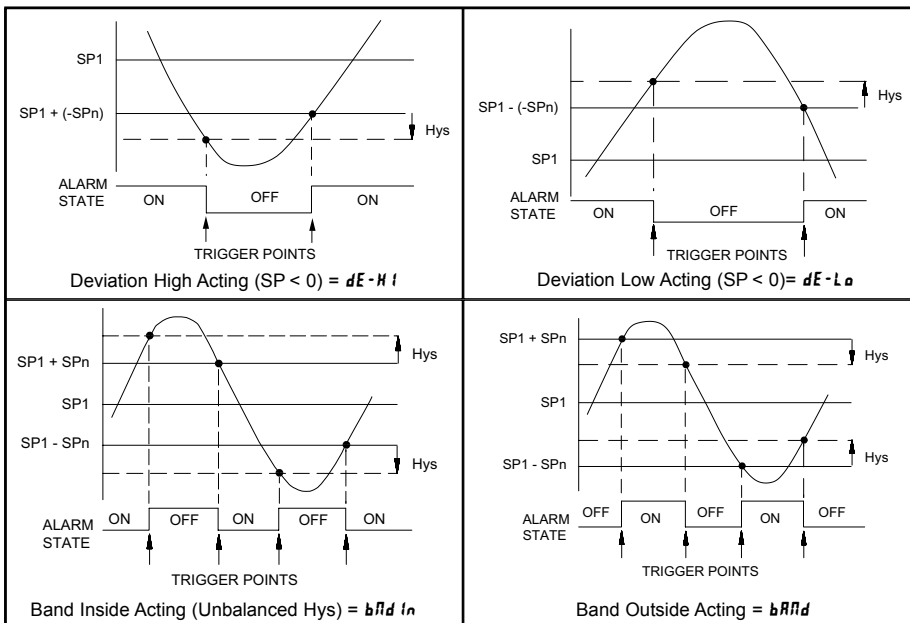

SETPOINT VALUE

SP-n ←
 ↩ **10.00**
 - 19999 to 99999

Enter desired setpoint alarm value. These setpoint values can also be entered in the Display Mode during Program Lock-out when the setpoint is programmed as **Enk** in Parameter Module 3. When a setpoint is programmed as deviation or band acting, the associated output tracks **SP I** as it is changed. The value entered is the offset, or difference from **SP I**.

OUTPUT LOGIC

out-n ←
 ↩ **nor**
 nor rEu

Enter the output logic of the alarm output. The **nor** logic leaves the output operation as normal. The **rEu** logic reverses the output logic. In **rEu**, the alarm states in the Setpoint Alarm Figures are reversed.

HYSTERESIS VALUE

HYS-n ←
 ↩ **0.02**
 I to 65000

Enter desired hysteresis value. See Setpoint Alarm Figures for visual explanation of how setpoint alarm actions (balance and unbalance) are affected by the hysteresis. When the setpoint is a control output, usually balance hysteresis is used. For alarm applications, usually unbalanced hysteresis is used. For unbalanced hysteresis modes, the hysteresis functions on the low side for high acting setpoints and functions on the high side for low acting setpoints.

Note: Hysteresis eliminates output chatter at the switch point, while time delay can be used to prevent false triggering during process transient events.

RESET ACTION

rSt-n ←
 ↩ **Auto**
 Auto LALC1 LALC2

Enter the reset action of the alarm output.

Auto = Automatic action; This action allows the alarm output to automatically reset off at the trigger points per the Setpoint Action shown in Setpoint Alarm Figures. The “on” alarm may be manually reset (off) immediately by a front panel function key or user input. The alarm remains reset off until the trigger point is crossed again.

LALC1 = Latch with immediate reset action; This action latches the alarm output on at the trigger point per the Setpoint Action shown in Setpoint Alarm Figures. Latch means that the alarm output can only be turned off by front panel function key or user input manual reset, serial reset command or meter power cycle. When the user input or function key is activated (momentary or maintained), the corresponding “on” alarm output is reset immediately and remains off until the trigger point is crossed again. (Previously latched alarms will be off if power up Display Value is lower than setpoint value.)

LALC2 = Latch with delay reset action; This action latches the alarm output on at the trigger point per the Setpoint Action shown in Setpoint Alarm Figures. Latch means that the alarm output can only be turned off by front panel function key or user input manual reset, serial reset command or meter power cycle. When the user input or function key is activated (momentary or maintained), the meter delays the event until the corresponding “on” alarm output crosses the trigger off point. (Previously latched alarms are off if power up Display Value is lower than setpoint value. During a power cycle, the meter erases a previous Latch 2 reset if it is not activated at power up.)

ON TIME DELAY

TON-n ←
 ↩ **0.0**
 0.0 to 3275.0 sec.

Enter the time value in seconds that the alarm is delayed from turning on after the trigger point is reached. A value of 0.0 allows the meter to update the alarm status per the response time listed in the Specifications. When the output logic is **rEu**, this becomes off time delay. Any time accumulated at power-off resets during power-up.

OFF TIME DELAY

TOF-n ←
 ↩ **0.0**
 0.0 to 3275.0 sec.

Enter the time value in seconds that the alarm is delayed from turning off after the trigger point is reached. A value of 0.0 allows the meter to update the alarm status per the response time listed in the Specifications. When the output logic is **rEu**, this becomes on time delay. Any time accumulated at power-off resets during power-up.

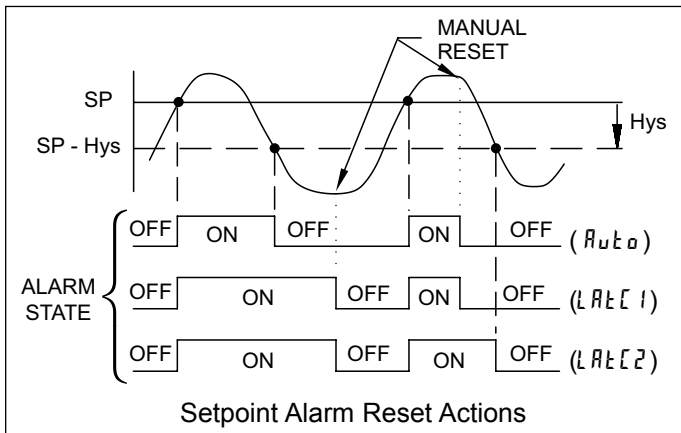

Setpoint Alarm Reset Actions

STANDBY OPERATION

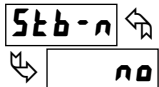

no YES

When **YES**, the alarm is disabled (after a power up) until the trigger point is crossed. Once the alarm is on, the alarm operates normally per the Setpoint Action and Reset Mode.

SETPOINT ANNUNCIATORS

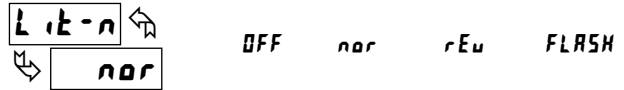

OFF nor rEu FLASH

The **OFF** mode disables display setpoint annunciators. The **nor** mode displays the corresponding setpoint annunciators of "on" alarm outputs. The **rEu** mode displays the corresponding setpoint annunciators of "off" alarms outputs. The **FLASH** mode flashes the corresponding setpoint annunciators of "on" alarm outputs.

Alternate Setpoints

An Alternate list of setpoint values can be stored and recalled as needed. The Alternate list allows an additional set of setpoint values. (The setpoint numbers nor rear terminal numbers will change in the Alternate list.) The Alternate list can only be activated through a function key or user input programmed for **L15t** in Module 2. When the Alternate list is selected, the Main list is stored and becomes inactive. When changing between Main and Alternate, the alarm state of Auto Reset Action alarms will always follow their new value. Latched "on" alarms will always stay latched during the transition and can only be reset with a user input or function key. Only during the function key or user input transition does the display indicate which list is being used.

6.7 MODULE 7 - SERIAL COMMUNICATIONS PARAMETERS (7-5rL) ▽

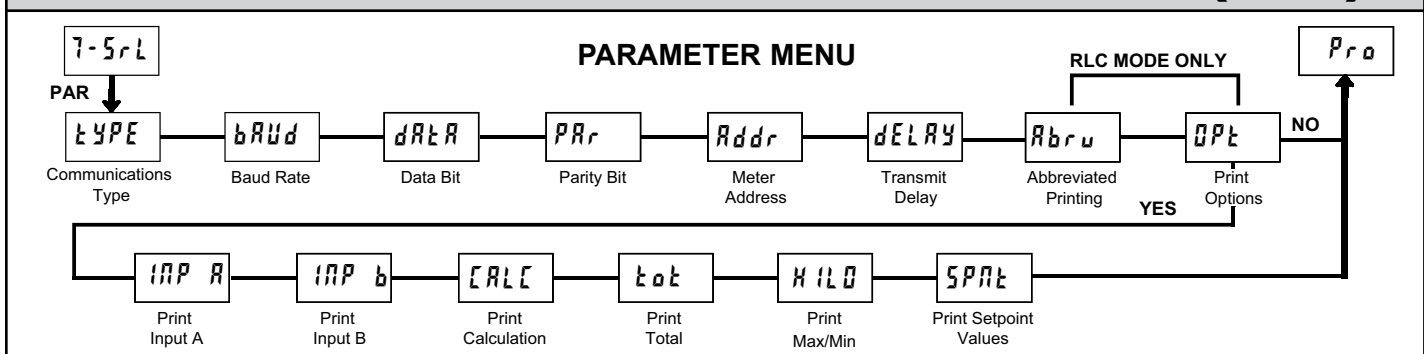

▽ - A communication card must be installed in order to access this module.

COMMUNICATIONS TYPE

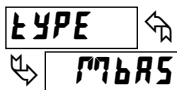

rLLc - RLC Protocol (ASCII)
 rLLbrt - Modbus RTU †
 rLLbAS - Modbus ASCII

Select the desired communications protocol. Modbus is preferred as it provides access to all meter values and parameters. Since the Modbus protocol is included within the PAXDP, the PAX Modbus option card, PAXCDC4, should not be used. The PAXCDC1 (RS485), or PAXCDC2 (RS232) card should be used instead.

BAUD RATE

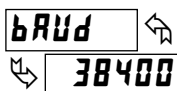

300 600 1200 2400
 4800 9600 19200 38400

Set the baud rate to match the other serial communications equipment on the serial link. Normally, the baud rate is set to the highest value that all the serial equipment are capable of transmitting and receiving.

† The Communication Type factory settings must be changed from the Modbus RTU for Crimson 2 communications.

DATA BIT



7 8

Select either 7 or 8 bit data word lengths. Set the word length to match the other serial communications equipment on the serial link.

PARITY BIT

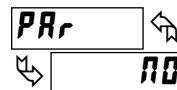

no EVEN odd

Set the parity bit to match that of the other serial communications equipment on the serial link. The meter ignores the parity when receiving data and sets the parity bit for outgoing data. If no parity is selected with 7 bit word length, an additional stop bit is used to force the frame size to 10 bits.

METER UNIT ADDRESS

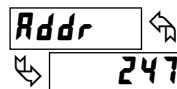

00 to 99 (RLC Protocol)
 1 to 247 (Modbus)

Enter the serial meter (node) address. The address range is dependent on the **tYPE** parameter. With a single unit, configured for RLC protocol (**tYPE** = rLLc), an address is not needed and a value of zero can be used. With multiple units (RS485 applications), a unique 2 digit address number must be assigned to each meter.

TRANSMIT DELAY



00 10 to 0,250

Following a transmit value (* terminator) or Modbus command, the PAXDP will wait this minimum amount of time in seconds before issuing a serial response.

CRIMSON SOFTWARE

When communicating with Crimson 2 software, the PAXDP must be set in default configuration type of:

Communications Type: MODBUS RTU †
 Baud Rate: 38400
 Data Bit: 8
 ParityBit: no
 Meter Unit Address: 247

Parameters below only appear when communications type (TYPE) parameter is set to RLC.

ABBREVIATED PRINTING



YES NO

Select NO for full print or Command T transmissions (meter address, parameter data and mnemonics) or YES for abbreviated print transmissions (parameter data only). This will affect all the parameters selected in the print options. (If the meter address is 00, it will not be sent during a full transmission.)

PRINT OPTIONS

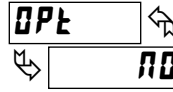

YES - Enters the sub-menu to select the meter parameters to appear during a print request. For each parameter in the sub-menu, select YES for that parameter information to be sent during a print request or NO for that parameter information not to be sent. A print request is sometimes referred to as a block print because more than one parameter information (meter address, parameter data and mnemonics) can be sent to a printer or computer as a block.

PARAMETER	DESCRIPTION
INP A	Input A Value
INP B	Input B Value
CALC	Calculation
Tot	Total Value
MAX & MIN	Max. & Min.
SPRt	Setpoint Values

SERIAL MODBUS COMMUNICATIONS

Modbus Communications requires that the Serial Communication Type Parameter (TYPE) be set to "RLC" or "PBR5".

SUPPORTED FUNCTION CODES

FC03: Read Holding Registers

- Up to 32 registers can be requested at one time.
- HEX <8000> is returned for non-used registers.

FC04: Read Input Registers

- Up to 32 registers can be requested at one time.
- Block starting point can not exceed register boundaries.
- HEX <8000> is returned in registers beyond the boundaries.
- Input registers are a mirror of Holding registers.

FC06: Preset Single Register

- HEX <8001> is echoed back when attempting to write to a read only register.
- If the write value exceeds the register limit (see Register Table), then that register value changes to its high or low limit. It is also returned in the response.

FC08: Diagnostics

The following is sent upon FC08 request:
 Module Address, 08 (FC code), 04 (byte count), "Total Comms" 2 byte count, "Total Good Comms" 2 byte count, checksum of the string
 "Total Comms" is the total number of messages received that were addressed to the PAXDP. "Total Good Comms" is the total messages received by the PAXDP with good address, parity and checksum. Both counters are reset to 0 upon response to FC08 and at power-up.

FC16: Preset Multiple Registers

- No response is given with an attempt to write to more than 32 registers at a time.
- Block starting point cannot exceed the read and write boundaries (4001-41280).

- If a multiple write includes read only registers, then only the write registers will change.
- If the write value exceeds the register limit (see Register Table), then that register value changes to its high or low limit.

FC17: Report Slave ID

The following is sent upon FC17 request:

RLC-PAXDP ab<0100h><20h><20h><10h>

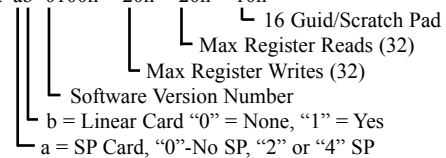

a = "0"(none), "2", "4" SP card installed
 b = "0"(none) or "1" Linear Card installed,

SUPPORTED EXCEPTION CODES

01: Illegal Function

Issued whenever the requested function is not implemented in the meter.

02: Illegal Data Address

Issued whenever an attempt is made to access a single register that does not exist (outside the implemented space) or to access a block of registers that falls completely outside the implemented space.

03: Illegal Data Value

Issued when an attempt is made to read or write more registers than the meter can handle in one request.

07: Negative Acknowledge

Issued when a write to a register is attempted with an invalid string length.

PAXDP FREQUENTLY USED MODBUS REGISTERS

Only frequently used registers are shown below. The entire Modbus Register Table can be found at www.redlion.net. The below limits are shown as Integers or HEX <> values. Read and write functions can be performed in either Integers or Hex as long as the conversion was done correctly. Negative numbers are represented by two's complement.

Note: The PAXDP should not be powered down while parameters are being changed. Doing so may corrupt the non-volatile memory resulting in checksum errors.

REGISTER ADDRESS ¹	REGISTER NAME	LOW LIMIT ²	HIGH LIMIT ²	FACTORY SETTING	ACCESS	COMMENTS
FREQUENTLY USED REGISTERS						
40001	Input A Relative Value (Hi word)	N/A	N/A	N/A	Read Only	Process value of present input level. This value is affected by Input Type, Resolution, Scaling & Offset Value (Relative Value = Absolute Input Value + Offset Value)
40002	Input A Relative Value (Lo word)					
40003	Input B Relative Value (Hi word)	N/A	N/A	N/A	Read Only	Process value of present input level. This value is affected by Input Type, Resolution, Scaling & Offset Value (Relative Value = Absolute Input Value + Offset Value)
40004	Input B Relative Value (Lo word)					
40005	Calculation Value (Hi word)	N/A	N/A	N/A	Read Only	Calculation Result of Math Function
40006	Calculation Value (Lo word)					
40007	Maximum Value (Hi word)	-19999	99999	N/A	Read/Write	
40008	Maximum Value (Lo word)					
40009	Minimum Value (Hi word)	-19999	99999	N/A	Read/Write	
40010	Minimum Value (Lo word)					
40011	Total Value (Hi word)	-199999000	999999000	N/A	Read/Write	
40012	Total Value (Lo word)					
40013	Setpoint 1 Value (Hi word)	-19999	99999	100	Read/Write	
40014	Setpoint 1 Value (Lo word)					
40015	Setpoint 2 Value (Hi word)	-19999	99999	200	Read/Write	
40016	Setpoint 2 Value (Lo word)					
40017	Setpoint 3 Value (Hi word)	-19999	99999	300	Read/Write	
40018	Setpoint 3 Value (Lo word)					
40019	Setpoint 4 Value (Hi word)	-19999	99999	400	Read/Write	
40020	Setpoint 4 Value (Lo word)					
40021	Setpoint Output Register (SOR)	0	15	N/A	Read/Write See Note	Status of Setpoint Outputs: Bit State: 0=Off, 1=On, Bit 3 = SP1, Bit 2 = SP2, Bit 1 = SP3, Bit 0 = SP4 Outputs can only be activated/reset with this register when respective bits in Manual Mode (MMR) register are set
40022	Manual Mode Register (MMR)	0	31	0	Read/Write	Bit State: 0=Auto Mode, 1=Manual Mode Bit 4 = SP1, Bit 3 = SP2, Bit 2 = SP3, Bit 1 = SP4, Bit 0 = Linear Output
40023	Reset Output Register	0	15	0	Read/Write	Bit State: 1= Reset Output; Bit is returned to zero following reset processing Bit 3 = SP1, Bit 2 = SP2, Bit 1 = SP3, Bit 0 = SP4
40024	Analog Output Register (AOR)	0	4095	0	Read/Write	Functional only if Linear Output is in manual mode (MMR bit 0 = 1). Linear Output Card is written to only if Linear Out (MMR bit 0) is set
40025	Input A Absolute Value (Hi word)	N/A	N/A	N/A	Read Only	Gross value of present Input A level. This value is affected by Input Type, Resolution, Scaling, but not affected by Offset Value
40026	Input A Absolute Value (Lo word)					
40027	Input B Absolute Value (Hi word)	N/A	N/A	N/A	Read Only	Gross value of present Input B level. This value is affected by Input Type, Resolution, Scaling, but not affected by Offset Value
40028	Input B Absolute Value (Lo word)					
40029	Input A Offset Value (Hi word)	-19999	99999	0	Read/Write	Relative Input Value (standard meter value) is sum of Input Offset Value and Input Absolute Value
40030	Input A Offset Value (Lo word)					
40031	Input B Offset Value (Hi word)	-19999	99999	0	Read/Write	Relative Input Value (standard meter value) is sum of Input Offset Value and Input Absolute Value
40032	Input B Offset Value (Lo word)					
40033	Main Setpoint 1 Value (Hi word)	-19999	99999	100	Read/Write	Setpoint List A
40034	Main Setpoint 1 Value (Lo word)					
40035	Main Setpoint 2 Value (Hi word)	-19999	99999	200	Read/Write	Setpoint List A
40036	Main Setpoint 2 Value (Lo word)					
40037	Main Setpoint 3 Value (Hi word)	-19999	99999	300	Read/Write	Setpoint List A
40038	Main Setpoint 3 Value (Lo word)					
40039	Main Setpoint 4 Value (Hi word)	-19999	99999	400	Read/Write	Setpoint List A
40040	Main Setpoint 4 Value (Lo word)					
40041	Alternate Setpoint 1 Value (Hi word)	-19999	99999	100	Read/Write	Setpoint List B
40042	Alternate Setpoint 1 Value (Lo word)					

¹ For Input Registers, replace the 4xxxx with a 3xxxx in the above register address. The 3xxxx are a mirror of the 4xxxx Holding Registers.

² An attempt to exceed a limit will set the register to its high or low limit value.

REGISTER ADDRESS ¹	REGISTER NAME	LOW LIMIT ²	HIGH LIMIT ²	FACTORY SETTING	ACCESS	COMMENTS
FREQUENTLY USED REGISTERS (Continued)						
40043	Alternate Setpoint 2 Value (Hi word)	-19999	99999	200	Read/Write	Setpoint List B
40044	Alternate Setpoint 2 Value (Lo word)	-19999	99999	300	Read/Write	Setpoint List B
40045	Alternate Setpoint 3 Value (Hi word)	-19999	99999	400	Read/Write	Setpoint List B
40046	Alternate Setpoint 3 Value (Lo word)	-19999	99999			
40047	Alternate Setpoint 4 Value (Hi word)	-19999	99999			
40048	Alternate Setpoint 4 Value (Lo word)	-19999	99999			

¹ For Input Registers, replace the 4xxx with a 3xxx in the above register address. The 3xxx are a mirror of the 4xxx Holding Registers.

² An attempt to exceed a limit will set the register to its high or low limit value.

SERIAL RLC PROTOCOL COMMUNICATIONS

RLC Communications requires the Serial Communications Type Parameter (**rSPE**) be set to **RLC**.

SENDING SERIAL COMMANDS AND DATA

When sending commands to the meter, a string containing at least one command character must be constructed. A command string consists of a command character, a value identifier, numerical data (if writing data to the meter) followed by a the command terminator character * or \$.

Command Chart

COMMAND	DESCRIPTION	NOTES
N	Node (Meter) Address Specifier	Address a specific meter. Must be followed by a one or two digit node address. Not required when address = 0.
T	Transmit Value (read)	Read a register from the meter. Must be followed by register ID character
V	Value Change (write)	Write to register of the meter. Must be followed by register ID character and numeric data.
R	Reset	Reset a register or output. Must be followed by register ID character.
P	Block Print Request (read)	Initiates a block print output. Registers are defined in programming.

Command String Construction

The command string must be constructed in a specific sequence. The meter does not respond with an error message to invalid commands. The following procedure details construction of a command string:

- The first characters consist of the Node Address Specifier (N) followed by a 1 or 2 character address number. The address number of the meter is programmable. If the node address is 0, this command and the node address itself may be omitted. This is the only command that may be used in conjunction with other commands.
- After the address specifier, the next character is the command character.
- The next character is the Register ID. This identifies the register that the command affects. The P command does not require a Register ID character. It prints according to the selections made in print options.
- If constructing a value change command (writing data), the numeric data is sent next.
- All command strings must be terminated with the string termination characters * or \$. The meter does not begin processing the command string until this character is received. See Timing Diagram figure for differences between terminating characters.

Register Identification Chart

ID	VALUE DESCRIPTION	REGISTER NAME ¹	COMMAND SUPPORTED ²
A	Input A Relative Value	INA	T, R (reset command zeros or tares input)
B	Input B Relative Value	INB	T, R (reset command zeros or tares input)
C	Calculation Value	CLC	T
D	Total	TOT	T, R (reset command zeros Total)
E	Min	MIN	T, R (reset command loads current reading)
F	Max	MAX	T, R (reset command loads current reading)
G	Input A Absolute (Gross) Value	ABA	T
H	Input B Absolute (Gross) Value	ABB	T
I	Input A Offset	OFA	T, V
J	Input B Offset	OFB	T, V
M	Setpoint 1	SP1	T, V, R (reset command resets setpoint output)
O	Setpoint 2	SP2	T, V, R (reset command resets setpoint output)
Q	Setpoint 3	SP3	T, V, R (reset command resets setpoint output)
S	Setpoint 4	SP4	T, V, R (reset command resets setpoint output)
U	Auto/Manual Register	MMR	T, V
W	Analog Output Register	AOR	T, V
X	Setpoint Register	SOR	T, V

- Register Names are also used as Register Mnemonics during full transmission.
- The registers associated with the P command are set up in Print Options (Module 7). Unless otherwise specified, the Transmit Details apply to both T and V Commands.

Command String Examples:

- Address = 17, Write 350 to Setpoint 1
String: N17VM350*
- Address = 5, Read Input A value
String: N5TA*
- Address = 0, Reset Setpoint 4 output
String: RS*

Transmitting Data To the Meter

Numeric data sent to the meter must be limited to Transmit Details listed in the Register Identification Chart. Leading zeros are ignored. Negative numbers must have a minus sign. The meter ignores any decimal point and conforms the number to the scaled resolution. (ie. The meter's scaled decimal point position is set for 0.0 and 25 is written to a register. The value of the register is now 2.5. In this case, write a value of 250 to equal 25.0).

Note: Since the meter does not issue a reply to value change commands, follow with a transmit value command for readback verification.

COMMAND RESPONSE TIME

The meter can only receive data or transmit data at any one time (half-duplex operation). When sending commands and data to the meter, a delay must be imposed before sending another command. This allows enough time for the meter to process the command and prepare for the next command.

At the start of the time interval t_1 , the computer program prints or writes the string to the com port, thus initiating a transmission. During t_1 , the command characters are under transmission and at the end of this period, the command terminating character (*) is received by the meter. The time duration of t_1 is dependent on the number of characters and baud rate of the channel.

$$t_1 = (10 * \# \text{ of characters}) / \text{baud rate}$$

At the start of time interval t_2 , the meter starts the interpretation of the command and when complete, performs the command function. This time interval t_2 varies from 2 msec to 15 msec. If no response from the meter is expected, the meter is ready to accept another command.

If the meter is to reply with data, the time interval t_2 is controlled by the use of the command terminating character and the Serial Transmit Delay parameter (**dELAY**). The standard command line terminating character is '*'. This terminating character results in a response time window of the Serial Transmit Delay time (**dELAY**) plus 15msec. maximum. The **dELAY** parameter should be programmed to a value that allows sufficient time for the release of the sending driver on the RS485 bus. Terminating the command line with 'S' results in a response time window (t_2) of 2 msec minimum and 15 msec maximum. The response time of this terminating character requires that sending drivers release within 2 msec after the terminating character is received.

At the beginning of time interval t_3 , the meter responds with the first character of the reply. As with t_1 , the time duration of t_3 is dependent on the number of characters and baud rate of the channel.

$$t_3 = (10 * \# \text{ of characters}) / \text{baud rate}$$

At the end of t_3 , the meter is ready to receive the next command. The maximum serial throughput of the meter is limited to the sum of the times t_1 , t_2 and t_3 .

Timing Diagrams

NO REPLY FROM METER

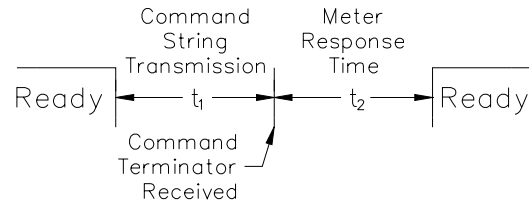

RESPONSE FROM METER

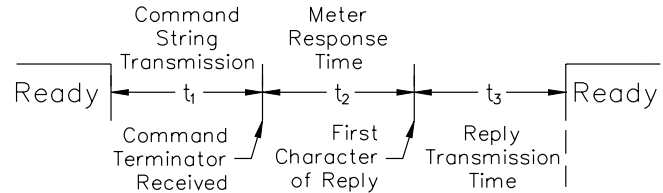

COMMUNICATION FORMAT

Data is transferred from the meter through a serial communication channel. In serial communications, the voltage is switched between a high and low level at a predetermined rate (baud rate) using ASCII encoding. The receiving device reads the voltage levels at the same intervals and then translates the switched levels back to a character.

The voltage level conventions depend on the interface standard. The table lists the voltage levels for each standard.

LOGIC	INTERFACE STATE	RS232*	RS485*
1	mark (idle)	TXD,RXD; -3 to -15 V	a-b < -200 mV
0	space (active)	TXD,RXD; +3 to +15 V	a-b > +200 mV

* Voltage levels at the Receiver

Data is transmitted one byte at a time with a variable idle period between characters (0 to ∞). Each ASCII character is "framed" with a beginning start bit, an optional parity bit and one or more ending stop bits. The data format and baud rate must match that of other equipment in order for communication to take place. The figures list the data formats employed by the meter.

Start bit and Data bits

Data transmission always begins with the start bit. The start bit signals the receiving device to prepare for reception of data. One bit period later, the least significant bit of the ASCII encoded character is transmitted, followed by the remaining data bits. The receiving device then reads each bit position as they are transmitted.

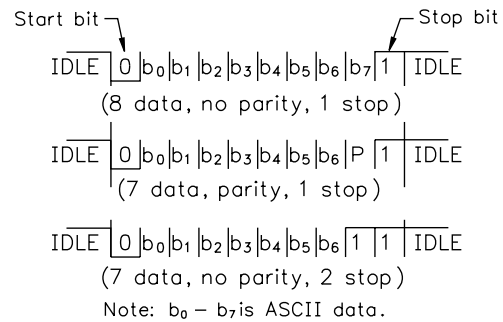

Character Frame Figure

Parity bit

After the data bits, the parity bit is sent. The transmitter sets the parity bit to a zero or a one, so that the total number of ones contained in the transmission (including the parity bit) is either even or odd. This bit is used by the receiver to detect errors that may occur to an odd number of bits in the transmission. However, a single parity bit cannot detect errors that may occur to an even number of bits. Given this limitation, the parity bit is often ignored by the receiving device. The PAX meter ignores the parity bit of incoming data and sets the parity bit to odd, even or none (mark parity) for outgoing data.

Stop bit

The last character transmitted is the stop bit. The stop bit provides a single bit period pause to allow the receiver to prepare to re-synchronize to the start of a new transmission (start bit of next byte). The receiver then continuously looks for the occurrence of the start bit. If 7 data bits and no parity is selected, then 2 stop bits are sent from the PAXDP.

6.8 MODULE 8 - ANALOG OUTPUT PARAMETERS (8-0ut) ▽

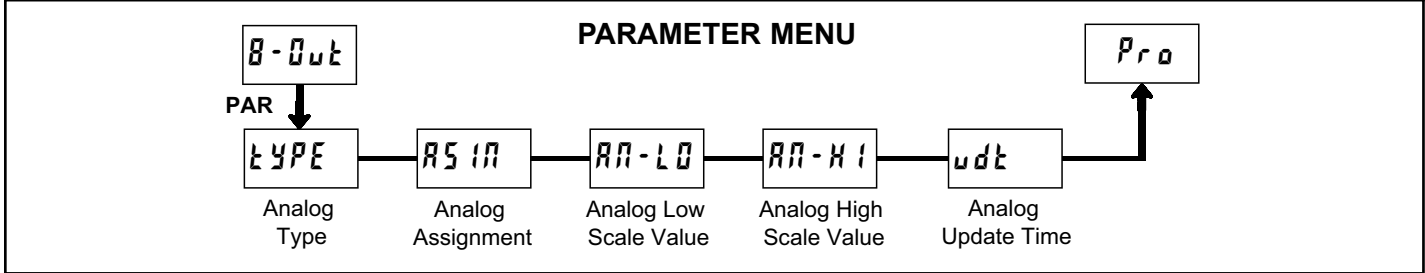

▽ - An analog output card must be installed in order to access this module.

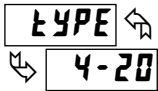

ANALOG TYPE

SELECTION	RANGE
0-20	0 to 20 mA
4-20	4 to 20 mA
0-10	0 to 10 V

Enter the analog output type. For 0-20 mA or 4-20 mA use terminals 18 and 19. For 0-10 V use terminals 16 and 17. Only one range can be used at a time.



ANALOG ASSIGNMENT

NONE	A-rEL	A-Rb5	b-rEL
b-Rb5	CRLE	tot	HI
			LO

Enter the source for the analog output to retransmit:
rEL = Relative (net) Input Value. The Relative Input Value is the Absolute Input Value that includes the Display Offset Value.
Rb5 = Absolute (gross) Input Value. The Absolute Input Value is based on Module 1 **d5P** and **INP** entries.
CRLE = Calculation Value
tot = Totalizer Value
LO = Minimum Display Value
HI = Maximum Display Value



ANALOG LOW SCALE VALUE

- 19999 to 99999

Enter the Display Value that corresponds to 0 mA (0-20 mA) , 4 mA (4-20 mA) or 0 VDC (0-10 VDC).



ANALOG HIGH SCALE VALUE

- 19999 to 99999

Enter the Display Value that corresponds to 20 mA (0-20 mA) , 20 mA (4-20 mA) or 10 VDC (0-10 VDC).

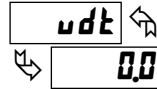

ANALOG UPDATE TIME

0.0 to 10.0

Enter the analog output update rate in seconds. A value of 0.0 allows the meter to update the analog output at the ADC Conversion Rate.

6.9 MODULE 9 - FACTORY SERVICE OPERATIONS (9-FL5)

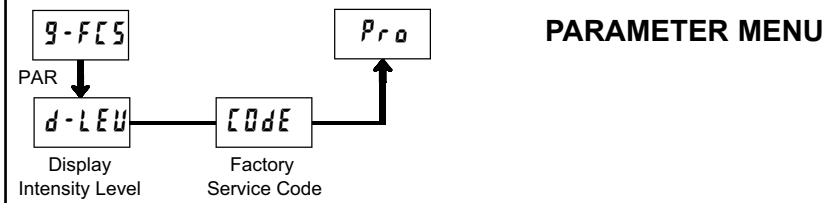

DISPLAY INTENSITY LEVEL

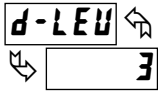

Enter the desired Display Intensity Level (0-15) by using the arrow keys. The display will actively dim or brighten as the levels are changed. This parameter also appears in Quick Programming Mode when enabled.

RESTORE FACTORY DEFAULTS

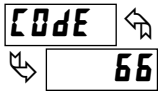

Use the arrow keys to display **CODE 66** and press **PAR**. The meter will display **RESET** and then return to **CODE 50**. Press **DSP** key to return to Display Mode. This will overwrite all user settings with the factory settings.

CALIBRATION

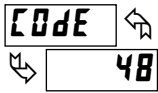

The meter has been fully calibrated at the factory. Scaling to convert the input signal to a desired display value is performed in Module 1. If the meter appears to be indicating incorrectly or inaccurately, refer to Troubleshooting before attempting to calibrate the meter.

When recalibration is required (generally every 2 years), it should only be performed by qualified technicians using appropriate equipment. Calibration does not change any user programmed parameters. However, it may affect the accuracy of the input signal values previously stored using the Apply (**APPLY**) Scaling Style.

Calibration may be aborted by disconnecting power to the meter before exiting Module 9. In this case, the existing calibration settings remain in effect.

INPUT CALIBRATION



WARNING: Calibration of this meter requires a signal source with an accuracy of 0.01% or better and an external meter with an accuracy of 0.005% or better.

Before starting, verify that the Input Ranger Jumper is set for the range to be calibrated. Also verify that the precision signal source is connected and ready. Allow a 30 minute warm-up period before calibrating the meter. **NO** and **PAR** can be chosen to exit the calibration mode without any changes taking place. Then perform the following procedure:

1. Use the arrow keys to display (**CODE 48**) and press **PAR**.
2. Choose the input channel/range to be calibrated by using the arrow keys and press **PAR**. (**NO** and **PAR** can be chosen to exit the calibration mode without any changes taking place.)
3. When the zero range limit appears on the display, apply the appropriate:
 - Voltage range: dead short applied
 - Current range: open circuit
4. Press **PAR** and the top range limit will appear on the display after approximately 1 second.
5. With the top range limit on the display, apply the appropriate:
 - Voltage range: 10 VDC
 - Current range: 20 mADC
6. Press **PAR** and **CAL**. **NO** will appear on the display after approximately 1 second.
7. When **NO** appears, press **PAR** twice.
8. If the meter is not field scaled, then the input display should match the value of the input signal.
9. Repeat the above procedure for each input range to be calibrated.

ANALOG OUTPUT CARD CALIBRATION

Before starting, verify that the precision voltmeter (voltage output) or current meter (current output) is connected and ready. Perform the following procedure:

1. Use the arrow keys to display **CODE 48** and press **PAR**.
2. Use the arrow keys to choose **OUT** and press **PAR**.
3. Using the chart below, step through the five selections to be calibrated. At each prompt, use the PAX arrow keys to adjust the external meter display to match the selection being calibrated. When the external reading matches, or if this range is not being calibrated, press **PAR**.

SELECTION	EXTERNAL METER	ACTION
00.A	0.00	Adjust if necessary, press PAR
40.A	4.00	Adjust if necessary, press PAR
200.A	20.00	Adjust if necessary, press PAR
00.u	0.00	Adjust if necessary, press PAR
100.u	10.00	Adjust if necessary, press PAR

4. When **NO** appears remove the external meters and press **PAR** twice.

TROUBLESHOOTING

PROBLEM	REMEDIES
NO DISPLAY	CHECK: Power level, power connections, Module 3 programming
PROGRAM LOCKED-OUT	CHECK: Active (lock-out) user input ENTER: Security code requested (222 = universal access code)
DISPLAY LOCKED-OUT	CHECK: Module 3 programming
INCORRECT INPUT DISPLAY VALUE	CHECK: Module 1 programming, Input Jumper position, input connections, input signal level, Module 4 Display Offset is zero, press DSP for Input Display PERFORM: Module 9 Calibration (If the above does not correct the problem.)
"OLOL" in DISPLAY (SIGNAL HIGH)	CHECK: Module 1 programming, Input Range Jumper position, input connections, input signal level
"ULUL" in DISPLAY (SIGNAL LOW)	CHECK: Module 1 programming, Input Range Jumper position, input connections, input signal level
JITTERY DISPLAY	INCREASE: Module 1 filtering, rounding, input range CHECK: Wiring is per EMC installation guidelines
MODULES or PARAMETERS NOT ACCESSIBLE	CHECK: Corresponding option card installation
ERROR CODE (Err xxx or EE xxx)	PRESS: Reset KEY (If cannot clear contact factory.)

For further assistance, contact technical support at the appropriate company numbers listed.

PARAMETER VALUE CHART PAXDP MODEL NUMBER _____

PROGRAMMER _____ DATE _____

METER# _____ SECURITY CODE _____

1- INP Signal Input Parameters

DISPLAY	PARAMETER	FACTORY SETTING	INPUT A USER SETTING	INPUT B USER SETTING	DISPLAY	PARAMETER	FACTORY SETTING	INPUT A USER SETTING	INPUT B USER SETTING
<i>r</i> ANGE	INPUT RANGE	40Lk	_____	_____	INP 7	INPUT VALUE 7	0.000	_____	_____
<i>r</i> AtE	UPDATE RANGE	198	_____	_____	dSP 7	DISPLAY VALUE 7	0.000	_____	_____
dEEPt	DISPLAY RESOLUTION	0.000	_____	_____	INP 8	INPUT VALUE 8	0.000	_____	_____
	DISPLAY ROUNDING INCREMENT	0.001	_____	_____	dSP 8	DISPLAY VALUE 8	0.000	_____	_____
<i>r</i> ound	FILTER SETTING	10	_____	_____	INP 9	INPUT VALUE 9	0.000	_____	_____
FILtEr	FILTER ENABLE BAND	0010	_____	_____	dSP 9	DISPLAY VALUE 9	0.000	_____	_____
bAND	SCALING POINTS	2	_____	_____	INP 10	INPUT VALUE 10	0.000	_____	_____
PtS	SCALING STYLE	KEY	_____	_____	dSP 10	DISPLAY VALUE 10	0.000	_____	_____
StYLE	INPUT VALUE 1	0.000	_____	_____	INP 11	INPUT VALUE 11	0.000	_____	_____
INP 1	DISPLAY VALUE 1	0.000	_____	_____	dSP 11	DISPLAY VALUE 11	0.000	_____	_____
dSP 1	INPUT VALUE 2	10.000	_____	_____	INP 12	INPUT VALUE 12	0.000	_____	_____
INP 2	DISPLAY VALUE 2	10.000	_____	_____	dSP 12	DISPLAY VALUE 12	0.000	_____	_____
dSP 2	INPUT VALUE 3	0.000	_____	_____	INP 13	INPUT VALUE 13	0.000	_____	_____
INP 3	DISPLAY VALUE 3	0.000	_____	_____	dSP 13	DISPLAY VALUE 13	0.000	_____	_____
dSP 3	INPUT VALUE 4	0.000	_____	_____	INP 14	INPUT VALUE 14	0.000	_____	_____
INP 4	DISPLAY VALUE 4	0.000	_____	_____	dSP 14	DISPLAY VALUE 14	0.000	_____	_____
dSP 4	INPUT VALUE 5	0.000	_____	_____	INP 15	INPUT VALUE 15	0.000	_____	_____
INP 5	DISPLAY VALUE 5	0.000	_____	_____	dSP 15	DISPLAY VALUE 15	0.000	_____	_____
dSP 5	INPUT VALUE 6	0.000	_____	_____	INP 16	INPUT VALUE 16	0.000	_____	_____
INP 6	DISPLAY VALUE 6	0.000	_____	_____	dSP 16	DISPLAY VALUE 16	0.000	_____	_____
dSP 6									

2-FNC User Input and Function Key Parameters

DISPLAY	PARAMETER	FACTORY SETTING	USER SETTING
USr-1	USER INPUT 1	NO	_____
USr-2	USER INPUT 2	NO	_____
F1	FUNCTION KEY 1	NO	_____
F2	FUNCTION KEY 2	NO	_____
rSt	RESET KEY	NO	_____
Sc-F1	2nd FUNCTION KEY 1	NO	_____
Sc-F2	2nd FUNCTION KEY 2	NO	_____

3-LCK Display and Program Lockout Parameters

DISPLAY	PARAMETER	FACTORY SETTING	USER SETTING
INP A	INPUT A ASSIGNMENT	dSP-A	_____
INP B	INPUT B ASSIGNMENT	dSP-b	_____
CALC	CALCULATION ASSIGNMENT	dSP-C	_____
H1	MAX DISPLAY LOCKOUT	L0C	_____
L0	MIN DISPLAY LOCKOUT	L0C	_____
	TOTAL DISPLAY LOCKOUT	L0C	_____
SP-1	SETPOINT 1 ACCESS	L0C	_____
SP-2	SETPOINT 2 ACCESS	L0C	_____
SP-3	SETPOINT 3 ACCESS	L0C	_____
SP-4	SETPOINT 4 ACCESS	L0C	_____
CODE	SECURITY CODE	0	_____

4-SEC Secondary Function Parameters

DISPLAY	PARAMETER	FACTORY SETTING	USER SETTING
OFFS-A	INPUT A OFFSET VALUE	0.000	_____
OFFS-b	INPUT B OFFSET VALUE	0.000	_____
H1-AS	MAX CAPTURE ASSIGNMENT	A-rEL	_____
H1-t	MAX CAPTURE DELAY TIME	10	_____
L0-AS	MIN CAPTURE ASSIGNMENT	A-rEL	_____
L0-t	MIN CAPTURE DELAY TIME	10	_____
dSP-t	DISPLAY UPDATE TIME	1	_____
b-L It	UNITS LABEL BACKLIGHT	OFF	_____
CFunc	CALCULATION FUNCTION	c-AR-1b	_____
C dP	CALCULATION DECIMAL POINT	0.000	_____
const	CALCULATION CONSTANT VALUE	1000	_____
C rnd	CALCULATION ROUNDING	0.001	_____
C FLt	CALCULATION FILTER SETTING	10	_____
C bnd	CALCULATION FILTER BAND	0.010	_____

5-SPt Setpoint (Alarm) Parameters

DISPLAY	PARAMETER	SP-1		SP-2		SP-3		SP-4	
		FACTORY SETTING	USER SETTING	FACTORY SETTING	USER SETTING	FACTORY SETTING	USER SETTING	FACTORY SETTING	USER SETTING
SPSEL	SELECT SETPOINT	NO	_____	NO	_____	NO	_____	NO	_____
ASn-n	SETPOINT ASSIGNMENT	NO/NE	_____	NO/NE	_____	NO/NE	_____	NO/NE	_____
ACT-n	SETPOINT ACTION	NO	_____	NO	_____	NO	_____	NO	_____
SP-n	SETPOINT VALUE (main)	100	_____	200	_____	300	_____	400	_____
	SETPOINT VALUE (alternate) *	100	_____	200	_____	300	_____	400	_____
HYS-n	SETPOINT HYSTERESIS	2	_____	2	_____	2	_____	2	_____
tON-n	ON TIME DELAY	0.0	_____	0.0	_____	0.0	_____	0.0	_____
tOFF-n	OFF TIME DELAY	0.0	_____	0.0	_____	0.0	_____	0.0	_____
out-n	OUTPUT LOGIC	nor	_____	nor	_____	nor	_____	nor	_____
rSt-n	RESET ACTION	RUt-o	_____	RUt-o	_____	RUt-o	_____	RUt-o	_____
Stb-n	STANDBY OPERATION	NO	_____	NO	_____	NO	_____	NO	_____
L It-n	SETPOINT ANNUNCIATORS	nor	_____	nor	_____	nor	_____	nor	_____

*Select alternate list to program these values.

5-Int Totalizer (Integrator) Parameters

DISPLAY	PARAMETER	FACTORY SETTING	USER SETTING
AS IN	TOTALIZER ASSIGNMENT	A-rEL	_____
DECPt	TOTALIZER DECIMAL POINT	0.000	_____
tBASE	TOTALIZER TIME BASE	1m	_____
SCFAC	TOTALIZER SCALE FACTOR	1000	_____
Locut	TOTALIZER LOW CUT VALUE	-19999	_____
P-uP	TOTALIZER POWER-UP RESET	NO	_____

7-5rL Serial Communication Parameters

DISPLAY	PARAMETER	FACTORY SETTING	USER SETTING
tYPE	COMMUNICATIONS TYPE	17bAS	_____
bAUD	BAUD RATE	38400	_____
dAtA	DATA BIT	8	_____
PAR	PARITY BIT	NO	_____
Addr	METER ADDRESS	247	_____
dELAY	TRANSMIT DELAY	0.010	_____
Abro	ABBREVIATED PRINTING	NO	_____
OPt	PRINT OPTIONS	NO	_____
INP A	INPUT A VALUE	NO	_____
INP B	INPUT B VALUE	NO	_____
CALC	CALCULATION	NO	_____
tot	PRINT TOTAL VALUE	NO	_____
H IL0	PRINT MAX & MIN VALUES	NO	_____
SPnt	PRINT SETPOINT VALUES	NO	_____

Shaded area available when communications type is rLL.

8-Out Analog Output Parameters

DISPLAY	PARAMETER	FACTORY SETTING	USER SETTING
tYPE	ANALOG TYPE	4-20	_____
AS IN	ANALOG ASSIGNMENT	0	_____
AN-L0	ANALOG LOW SCALE VALUE	0	_____
AN-H1	ANALOG HIGH SCALE VALUE	10000	_____
udt	ANALOG UPDATE TIME	0.0	_____

9-FCS Factory Setting Parameters

DISPLAY	PARAMETER	FACTORY SETTING	USER SETTING
d-LEV	DISPLAY INTENSITY LEVEL	3	_____

LIMITED WARRANTY

(a) Red Lion Controls Inc., Sixnet Inc., N-Tron Corporation, or Blue Tree Wireless Data, Inc. (the "Company") warrants that all Products shall be free from defects in material and workmanship under normal use for the period of time provided in "Statement of Warranty Periods" (available at www.redlion.net) current at the time of shipment of the Products (the "Warranty Period"). **EXCEPT FOR THE ABOVE-STATED WARRANTY, COMPANY MAKES NO WARRANTY WHATSOEVER WITH RESPECT TO THE PRODUCTS, INCLUDING ANY (A) WARRANTY OF MERCHANTABILITY; (B) WARRANTY OF FITNESS FOR A PARTICULAR PURPOSE; OR (C) WARRANTY AGAINST INFRINGEMENT OF INTELLECTUAL PROPERTY RIGHTS OF A THIRD PARTY; WHETHER EXPRESS OR IMPLIED BY LAW, COURSE OF DEALING, COURSE OF PERFORMANCE, USAGE OF TRADE OR OTHERWISE.** Customer shall be responsible for determining that a Product is suitable for Customer's use and that such use complies with any applicable local, state or federal law.

(b) The Company shall not be liable for a breach of the warranty set forth in paragraph (a) if (i) the defect is a result of Customer's failure to store, install, commission or maintain the Product according to specifications; (ii) Customer alters or repairs such Product without the prior written consent of Company.

(c) Subject to paragraph (b), with respect to any such Product during the Warranty Period, Company shall, in its sole discretion, either (i) repair or replace the Product; or (ii) credit or refund the price of Product provided that, if Company so requests, Customer shall, at Company's expense, return such Product to Company.

(d) **THE REMEDIES SET FORTH IN PARAGRAPH (c) SHALL BE THE CUSTOMER'S SOLE AND EXCLUSIVE REMEDY AND COMPANY'S ENTIRE LIABILITY FOR ANY BREACH OF THE LIMITED WARRANTY SET FORTH IN PARAGRAPH (a).**

Red Lion Controls
Headquarters
20 Willow Springs Circle
York PA 17406
Tel +1 (717) 767-6511
Fax +1 (717) 764-0839

Red Lion Controls
Europe
Softwareweg 9
NL - 3821 BN Amersfoort
Tel +31 (0) 334 723 225
Fax +31 (0) 334 893 793

Red Lion Controls
India
201-B, 2nd Floor, Park Centra
Opp 32 Mile Stone, Sector-30
Gurgaon-122002 Haryana, India
Tel +91 984 487 0503

Red Lion Controls
China
Unit 1102, XinMao Plaza
Building 9, No.99 Tianzhou Road
ShangHai, P.R. China 200223
Tel +86 21 6113 3688
Fax +86 21 6113 3683